

• Behind the News • Health • UFOs • Future Science •

# NEXUS

NEW TIMES • Vol 7, No 4

JUNE - JULY 2000

AUSTRALIA	\$4.95
NZ (incl GST)	NZD \$5.95
USA	USD \$4.95
CANADA	CAN \$6.95
UK	STG £2.50
NETHERLANDS	NFL f8.95

The hidden dangers of  
**Food Additives**

**Project Censored:**  
stories the media ignored

The CIA, UFOs, MJ-12, JFK  
& James Jesus Angleton

**Vibrational Medicine:**  
Radionics and Homoeopathy

**Bedini's Free Energy Motor**

ISSN 1039-0170

ISSN 1039-0170



9 771039 017000

Print Post Approved PP442036/0005

• Echelon • Infrasound Weapons • Pyramid Tunnels •

# NEXUS

NEW TIMES MAGAZINE

Volume 7, Number 4 JUNE – JULY 2000

PO Box 30, Mapleton Qld 4560, Australia

## CONTENTS

LETTERS TO THE EDITOR.....	4	SCIENCE NEWS.....	55
GLOBAL NEWS.....	6	<i>By John C. Bedini. US inventor John Bedini recently put plans for his free-energy motor on the Internet, after helping a 10-year-old schoolgirl win science awards for running the motor non-stop for four days.</i>	
<i>News and views, from the digital supervirus threat and MI5's new e-mail monitoring capability, to why a key Lockerbie witness can't testify.</i>		THE CIA, MJ-12, JFK & JAMES JESUS ANGLETON.....	59
DeBRIEFINGS: BEHIND THE HEADLINES.....	11	<i>By Timothy S. Cooper. In his role as the CIA's Chief of Counterintelligence with an eye on the Soviets, James Jesus Angleton was privy to Top Secret/MJ-12 UFO data which President Kennedy tried hard to access before he was assassinated.</i>	
<i>An update on drug pollutants in North American waters; Kenn Thomas on the connection between Echelon and the infamous PROMIS software; and new findings on the MMR vaccine's link to autism.</i>		THE TWILIGHT ZONE.....	67
PROJECT CENSORED'S 25 TOP NEWS STORIES.....	17	<i>This issue we look at a B-29 gunner's version of the Roswell incident; an ancient city alleged to be beneath Death Valley, California; and the discovery of previously unknown chambers and a tunnel in Egypt's Meidum pyramid, built around 2600 BC.</i>	
<i>Compiled by the Project Censored team, this list of the most under-covered stories in the US last year includes the return of the "Star Wars" space weapon system, NATO's defence of corporate interests in the Balkans, and toxic racism in Louisiana.</i>		REVIEWS—Books.....	71
THE INTERNATIONAL DRUG COMPLEX—Part 2.....	25	<i>"The Toxic Playground" by Jo Immig</i>	
<i>By Hans T. van der Veen. Organised crime groups have globalised the illegal drug industry in cooperation with established power elites, while subverting political and economic structures and disempowering individuals, societies and nations.</i>		<i>"Global Spin" by Sharon Beder</i>	
EXCITOTOXIC FOOD ADDITIVES—Part 1.....	33	<i>"Celtic Mysteries in New England" by P. Imbrogno and M. Horrigan</i>	
<i>By Dr Russell L. Blaylock. Evidence is growing that processed food additives like MSG and aspartame are "excitotoxins" which react with brain receptors, kill neurons and cause neurological disorders.</i>		<i>"The Tutankhamun Prophecies" by Maurice Cotterell</i>	
DR GAVREAU'S INFRASONIC WEAPON.....	39	<i>"Roswell 1947: 'I Was There'" by Robert J. Shirkey</i>	
<i>By Gerry Vassilatos. Dangerous infrasound can be generated by both natural phenomena and the built environment. In the late 1950s and 1960s, French robotics scientist Dr Vladimir Gavreau found a way to detect it, weaponise it and defend against it.</i>		<i>"The Out-of-Body Experience" by Graham Dack</i>	
SWIMMING THROUGH THE ETHER.....	47	<i>"Vaccination: The Right Choice?" by Maureen Hickman</i>	
<i>By Nick Franks. The vibrational healing techniques of radionics and homoeopathy can be better understood in terms of an esoteric scientific model which recognises the nature of nonmaterial reality.</i>		<i>"Magical and Mystical Sites" by Elizabeth Pepper and John Wilcock</i>	
		<i>"The Living Energy Universe" by Gary Schwartz and Linda Russek</i>	
		<i>"Cyberculture Counterconspiracy" edited by Kenn Thomas</i>	
		<i>"The People Before" by Gary J. Cook and Thomas J. Brown</i>	
		<i>"The Pure State of Nature" by David Horton</i>	
		<i>"The Thread of Infinity" by Jon Whistler</i>	
		<i>"The Grand Design, Volumes 1 &amp; 2" by Paddy McMahon</i>	
		<i>"Conspiranoia!" by Devon Jackson</i>	
		REVIEWS—Videos.....	78
		<i>"UFO Down-Under" by Barry Taylor</i>	
		REVIEWS—Music.....	79
		<i>"Taralinga Lila" by Sangeet, Tarshito, Jimmy</i>	
		<i>"Republica Dominicana" by various artists</i>	
		<i>"Beyond Skin" by Nitin Sawhney</i>	
		<i>"Tribe" by Tribe</i>	
		<i>"Shafqat Ali Khan" by Shafqat Ali Khan</i>	
		NEXUS BOOKS, VIDEOS, ADS, SUBS.....	88-96

# NEXUS MAGAZINE

Volume 7, Number 4

JUNE – JULY 2000

PUBLISHED BY

NEXUS Magazine Pty Ltd, ABN 80 003 611 434

EDITOR

Duncan M. Roads

CO-EDITOR

Catherine Simons

ASSISTANT EDITOR/SUB-EDITOR

Ruth Parnell

EDITORS' ASSISTANT

Richard Giles

OFFICE ADMINISTRATOR

Janine Carmichael

CONTRIBUTORS THIS ISSUE

Kenn Thomas; Project Censored;

Hans T. van der Veen;

Russell L. Blaylock, MD; Gerry Vassilatos;

Nick Franks; John Bedini;

Timothy S. Cooper; George Filer

CARTOONS

Phil Somerville

COVER GRAPHIC

John Cook, jscook@ozemail.com.au

PRINTING

Warwick Daily News, Queensland, Australia

AUSTRALIAN DISTRIBUTION

Newsagents Direct Distribution

HEAD OFFICE – All Correspondence

PO Box 30, Mapleton, Qld 4560, Australia

Tel: (07) 5442 9280; Fax: (07) 5442 9381

E-mail: editor@nexusmagazine.com

Web page: www.nexusmagazine.com

NEW ZEALAND OFFICE

RD 2, Kaeo, Northland

Tel: +64 (0)9 405 1963; Fax: +64 (0)9 405 1964

E-mail: nexusnz@xtra.co.nz

USA OFFICE - 2940 E. Colfax, #131,

Denver CO 80206

Tel: 303 321 5006; Fax: 603 754 4744

E-mail: nexususa@earthlink.net

UK OFFICE - 55 Queens Rd, East Grinstead, West

Sussex, RH19 1BG. Tel: +44 (0)1342 322854;

Fax: +44 (0)1342 324574

E-mail: nexus@ukoffice.u-net.com

EUROPE OFFICE - PO Box 372, 8250 AJ Dronten,

The Netherlands. Tel: +31 (0)321 380558;

Fax: +31 (0)321 318892

STATEMENT OF PURPOSE

NEXUS recognises that humanity is undergoing a massive transformation. With this in mind, NEXUS seeks to provide 'hard-to-get' information so as to assist people through these changes. NEXUS is not linked to any religious, philosophical or political ideology or organisation.

PERMISSION-TO-REPRODUCE POLICY

While reproduction and dissemination of the information in NEXUS is actively encouraged, anyone caught making a buck out of it, without our express permission, will be in trouble when we catch them!

## Editorial

Like many NEXUS readers, I often spend time wondering who and what is 'behind it all'. Is 'life' just the product of a mechanistic universe devoid of any meaning? Or is there meaning to it all? And, if so, what?

On a more localised level, I find myself fascinated with mass events and the question of whether they are being 'guided' by an unseen hand or are just randomly driven by the attitudes of the masses. In this modern era, it is plain to see (for those who care to look) that many forces driving our social 'progression' are organised and are financially motivated.

The drive to unite countries into continent-sized trading blocks did not emerge from the citizens of those countries. The drive to set global standards on things like the recommended daily dosage of vitamin C (as with the Codex Alimentarius Commission), or the push to combine many national currencies into one new denomination, has not emerged from those representative nations. This 'push' towards globalisation is not being driven by the ordinary people: it is clearly being driven by an elite from behind the scenes.

This is no longer conspiracy theory: it is observable fact! On the surface it is easy to point to transnational corporations and their obvious profit motive. But look at the interlocking control of those powerful, long-standing corporations from a viewpoint of family bloodlines and you get a whole new perspective.

But, just who comprises this 'elite'—and what their motives and goals are—is the subject of many a conspiracy theory. Has this elite existed for a long time? If so, how far back do they go? Are they any particular race or religion? Is it just a rich ruling-class with no more meaning to their lives except to amass more power and wealth? Are they terrestrial or non-terrestrial? Are they from an inner Earth civilisation or do they shape-shift? Are 'they' even from this dimension?

There are several viewpoints of 'the big picture' of life which involve the concept of other-dimensional beings who 'feed' off emotional energy emitted by humans. One compelling book I read recently contained this very idea. In *The Thread of Infinity* (see review this issue), the "Lords of the Higher Realms" live non-physically but have lesser minions actively (physically) engaged here on planet Earth, stirring up trouble. They instigate and steer vast conspiracies, many of which are hauntingly familiar. Their goal is to control our egos. The 'good' guys seek to encourage us to connect our souls with our egos and awaken to the God within each of us. The 'bad' guys want us to focus our attention (and our beliefs) outwards—on survival, money, sex, religion, entertainment, good times, wars and problems. Our resulting emotional stress is all they want. To them it is an energy source, much like food/emotions/sex combined.

My own perceptions of history tell me that forces behind the scenes are coming close to achieving a long-held goal of globalisation. What has always puzzled me, is why this elite has focused on using war, suffering, coercion, terror and external force as their preferred tools to effect change. Why not use love, greatness and example as an incentive? Surely it is far cheaper, more effective, more permanent and, above all, more pleasant.

I have personally seen many problems 'solved' with lose-lose-lose situations, when they could easily have been solved with win-win-win situations. This occurs on all levels of government on a regular basis, and I am not alone in this observation. I'm coming close to concluding that there is no rational reason for this. I cannot see how even transnationals benefit from such short-term thinking.

In one of his out-of-body explorations, Robert Monroe, founder of The Monroe Institute, was told that life on Earth is unique, and that it was created by beings who use our emotional output as a food source. This revelation put the poor guy into shock for weeks! After all, discovering that we humans may not be at the end of the 'food' chain is not something we want to tell the kids, is it?

So as you read this issue of NEXUS, spare a loving thought for those you may be 'feeding'!

— Duncan

## WARRANTY AND INDEMNITY

Advertisers upon and by lodging material with the Publisher for publication or authorising or approving of the publication of any material INDEMNIFY the Publisher and its servants and agents against all liability claims or proceedings whatsoever arising from the publication and without limiting the generality of the foregoing to indemnify each of them in relation to defamation, slander of title, breach of copyright, infringement of trademarks or names of publication titles, unfair competition or trade practices, royalties or violation of rights or privacy AND WARRANT that the material complies with all relevant laws and regulations and that its publication will not give rise to any rights against or liabilities in the Publisher, its servants or agents and in particular that nothing therein is capable of being misleading or deceptive or otherwise in breach of the Part V of the Trade Practices Act 1974. All expressions of opinion are published on the basis that they are not to be regarded as expressing the opinion of the Publisher or its servants or agents. Editorial advice is not specific and readers are advised to seek professional help for individual problems.

© NEXUS New Times 2000



# Letters to the Editor ...

## Chemtrails over Newcastle?

Dear Duncan: At 11.00 am on 27 March, while at Tenambit (an outer suburb of Newcastle, NSW), I saw white "streams" drifting through the sky to the left and right, as far as the eye could see, in front and behind me, drifting along in the breeze—streams from five feet to 50 feet long!

Some of the streams, or "webs", came within reach, so I picked them out of the air. It felt like cobwebs, but the web contained about 30 to 40 strands and the beginning of it seemed like a ball of web, and it looked like a gigantic spider web! I commented to friends that it was "space sperm", and everyone (10 of them) was amazed at the amount that was floating through the sky, as far as the eye could see!

I rolled up the web and threw it away. I thought no more of it until I discussed it with one of your readers (the co-ordinator of the NEXUS discussion group) who then located your story in vol. 6, no. 3, April–May 1999 issue. I would be interested to find out if people in the area are being affected in the same way as in the US and elsewhere.

We've decided to send a copy of the article to a local doctor to see if, in fact, any negative effects are being felt. Let's hope not.

Sincerely, Kurt King, Cardiff, New South Wales, Australia

## Computer Precautions

Dear Duncan: Thanks for the April–May 2K NEXUS.

Denis Coone (Letters, 7/03) could, as may anyone else, prevent his hard disc from being viewed whilst he was on the Net by installing a Firewall program available from many of the shareware distributors that advertise in the computer mags. The viewing programs are installed on the PC from attachments on Urgent: Open Now e-mails. Moral: don't open junk mail!

Most ISPs that supply free discs/CDs use tailored packages that cannot be used on a "dial-up" independent ISP such as Totalserve (UK only), so changing ISP could be difficult.

A word of caution. Remember Gary Glitter? He fell foul of UK law, being "caught in possession of" prohibited (in UK) material on his HD. That he viewed it is

not in dispute, but that he *saved* it is. Have you looked at the Directory Cache in your Net files? Unless you are lucky enough for it to be purged each time you leave the Net, then it will be massive, containing every page you have ever looked at. All files will be HTM. Open one up under Explorer or Navigator and you will see; there will be no graphics because the file names were changed, but they are there as GIF. Load one into a DTP and see! Remember it now? Okay, so now go and delete the contents of cache; better to use something like SWIPE.EXE which renders the files *totally* unrecoverable. In fact, use that to remove anything that could be "sensitive".

Remember, Big Brother is watching you, and he is severely paranoid!

Regards, Alan M. Levett, Glastonbury, Somerset, UK

## Flaws in Citing Animal Studies

Dear Duncan: I'm sorry, but an article peppered with so many references to animal studies instantly loses its credibility—ref. "Soy Products: Tragedy and Hype" by Sally Fallon, NEXUS 7/03, April–May 2000.

Results from experiments on animals cannot be accurately extrapolated to another animal species, let alone to humans. In fact, the results can vary even within the same species, depending on the conditions at the time, strain of animal, time of day, etc.

The statement, that Dr Claude Hughes's "research suggests that the effects observed in rats 'will be at least somewhat predictive of what occurs in humans'" is nonsense and completely unscientific. Animal experiments have absolutely no predictive value for humans. If similar results occur in humans, it is pure coincidence, the human studies providing the real evidence.

Numerous animal experiments had been conducted on DES before it was pronounced safe for marketing. These experiments did not prevent the daughters of women who took the drug during pregnancy from suffering cancer when they reached their twenties, but provided the pharmaceutical companies with an alibi. That is, all the required tests had been performed and, anyway, as they

admit, animal tests are unreliable—a win-win situation!

So please, let's kick this flawed methodology into touch before it does any more damage and leads us forever up the garden path.

Sheila Edwards, Dubai, UAE

## Mind-Expanding Magazine

Thank you for a very stimulating magazine and a useful website. I have been reading your magazine for about three years now and, although I have to take some of the material with a huge pinch of salt, there is plenty that is mind-expanding. I particularly appreciate it when I find a good bibliography at the end of the articles, or at least some way in which I can obtain supporting material at little or no cost.

However, a few articles have appeared to be little more than imaginative money-making schemes/ideas/ventures. It is obvious that many people have very different realities. The world they see is quite different to the one I see. It's hard to say whose reality is correct at times.

I particularly enjoy articles in the areas of health, science and technology, where it seems to be the case that many useful, sometimes revolutionary ideas can be rejected out of hand because they don't fit with the current accepted paradigm. Peer review is extremely conservative, sometimes usefully so, but I believe that too much valuable material is being pushed to one side.

People are generally reluctant to allow their cages to be rattled (see "Why don't people listen?" by Hugh Mackay). Our economic system, unfortunately, has to take the blame for many of the ills of the world today. Large organisations take on a life and momentum of their own, quite out of the control of the management who are legally bound to maximise shareholder returns (a little simplified). Individual directors of a public company would have to be almost suicidal to step out of line with their fellow board members. Many of the individuals who work for some of the world's most damaging organisations are the nicest people you could wish to meet, but are in practical terms powerless to do anything about improving matters.

Meanwhile, please keep on rattling *my* cage! Life is much more rewarding when one's beliefs are challenged.

Best wishes, David Tweedie, Adelaide, South Australia, vaccess@adelaide.on.net

## Sensitive Street Lights

Dear Editors: The phenomenon I am about to describe has been put on videotape. Some time in 1992, I began to be aware of the fact that certain types of street lights reacted to my presence. By June of 1999 I was certain that this was the case.

I am an artist, and at the time of the first occurrence I lived in the industrial area of Albuquerque, near the railroad tracks. I might never have been aware of this phenomenon except for the fact that I lived in a poorly lit part of town. I took regular nightly walks and began to notice the fact that two of the street lights began to behave in an erratic manner. They simply blinked off as I approached, and then came back on within a minute or two.

At first I dismissed the event, assuming that something was wrong with the lighting. Then I noticed that it began to happen in other parts of town after I had moved from the original location. The necessary ingredient seems to be repetitive passes. The lights behaved in a way unlike anything I had ever seen.

The type of light which reacts to my presence is that which has light-sensing photo cells. I believe they are referred to as halogen lights, though I have not done the research to verify this. This is the type of lighting which comes on automatically as it gets dark. Lights which are on straight timers appear to be unaffected. At first I thought that the phenomenon happened only through repeated walking in the proximity of the lights. I have found recently that I can be riding in a car, as well as outdoors; the lights will respond in the same way. The sensing device in the light can pick me up as far away as one or two hundred feet.

I wish to clarify the fact that only a small percentage of photo-sensitive lights react to my presence at any one time. The number increases daily and the locations affected are increasing. I

# ... more Letters to the Editor

**NB: Please keep letters to approx. 100 to 150 words in length. Ed.**

suppose the interesting aspect of this phenomenon is that I am able to predict the area of town where more lights will behave erratically, and find them.

After the initial contact and blink-off, the light no longer behaves normally and appears to be permanently disrupted, though it does not go black, but the filament, if that's the correct nomenclature, remains barely lit until it comes back on full force. It begins to cycle on and off in periods of 20 seconds up to two minutes or more. This lasts indefinitely. For all practical purposes, the light is broken and must eventually be replaced.

In September of 1999, I began to videotape the various kinds of lights and their unusual behaviour. Some were on busy streets, others in school yards or parking lots. If I were to draw a map of the locations of the lights, it would very clearly delineate a route which I have either walked (I am an addictive walker) or driven on a regular basis. This type of erratic behaviour can only be found on the route described, which extends from my neighbourhood to my parents' house, several miles away.

There are six lights flashing on and off in the school yard next door to my parents' house, as I write, and there will be more because the entire school yard is ringed with the same type of lighting. Within the compound where my parents live, about six lights have been affected. This type of lighting behaves differently in that it flickers continuously until it goes black. Two of these have already been replaced. A new one began flickering last night.

There are other non-functional lights, of course, on other streets and parts of town, but they are simply black, and remain that way. I have counted some 27 lights on the above-described route that behave erratically. These ceased to function one by one. Someone will eventually notice, and they will be replaced. But by then there will be many more in other parts of town.

From what I have observed, it is the sensing mechanism that is disrupted, not the flow of juice. Once this takes place, the light no longer functions normally; it blinks on and off in an erratic

cycle. I have not yet contacted anyone who understands the operating mechanism in these lights. I have not heard of anyone else who has experienced the same phenomenon. Perhaps you have. Filming it is the only way to be sure.

If you have any ideas about an article, or are interested in the videotape, please contact me.

Sincerely, Janusz Kozikowski, Albuquerque, New Mexico, USA

## Cancer Cure Testimonials

Dear Duncan, I've been researching the cancer cure cover-up story for a number of years now, and I am currently writing a book on the subject (for which NEXUS has proved an invaluable resource). I am in the process of gathering testimonials from cancer patients who have used Essiac, Hoxsey method, Gerson method, Rife treatment, Clark's zappers, Naessens's 714X, Cancell or oxygen therapy.

I thought that as NEXUS has run features on these, and advertises some of the products, it would be a perfect place to contact people who are anxious to share their story with the world. Highlighting this story is one of the most important things NEXUS has done, and the more people who know, the better.

Anyone who wants to contact me regarding this is welcome to e-mail me on [ralph\\_cohen@hotmail.com](mailto:ralph_cohen@hotmail.com).

Thanks, Duncan. Keep fighting the good fight.

Sincerely, Ralph Cohen

## Side Effects of Soy Milk

Dear NEXUS: I would like to congratulate NEXUS on successfully delivering yet another enlightening and informative article, explaining the possible risks of soy and soy products [7/03].

My initial reaction to this article was one of total shock, disbelief and disappointment. Hoping this not to be true, I desperately searched the Internet looking for articles that might oppose such claims. Alas, to no avail.

I use the word "enlightening" because it was this article that brought attention to the fact that, ever since I have been drinking soy milk, I have found myself menstruating 2-3 times a month! At first, I found no connection

and just assumed that it was my body adjusting to this new diet. However, I then spoke to a girlfriend who has been going through exactly the same thing for the past two years after drinking soy milk! Needless to say, we instantly made the connection and have since stopped. At this stage I would like to point out that, for her, the search for answers from doctors and naturopaths has been futile. Their responses were simply "stress".

After this series of revelations, I asked Sanitarium if they could comment on the article. I feel this request was justified as I have used some of their products, based on the fact that they state they are a "health food company". They sent a reply which contains the following excerpt: "The points made in the article are not original, being a compendium of circulating views and selected (apparently) contradictory research. A combination of both science and advocacy, one would think, making bad use of good science, and in a very convincing manner..." I then sent another e-mail, asking if they could then suggest another reason for why I was constantly menstruating, and to date have received no reply.

So, please be warned. If you would like further information, please contact me at [n.ford@rmit.edu.au](mailto:n.ford@rmit.edu.au).

Regards, Natalie Ford, Surrey Hills, Victoria, Australia

## Space Quanta Technology

Ladies and Gentlemen: Re transmutation of elements, with the goal to decrease radioactivity and/or to convert surplus energy into thermal or electrical energy, for many years I have been watching the activities in the field of free energy (over unity) as well as some border areas. Professionally, as well as privately, I am working in this field for several parties.

I am very well acquainted with the group nearby doing research in space quanta technology. Members, readers or Internet visitors of your organisation surely would be interested to know that specialists in this group recently gained some pioneering knowledge in the abovementioned fields.

My point (and the purpose of

this e-mail message) is to draw the attention of your members, readers or Internet visitors to the recently published article by DSc. Nat. Hans Weber, who, as the leading researcher, discusses the above subjects. The complete article can be found on the Internet at <http://www.rqm.ch/engl/chance.htm>.

I would appreciate it if you could publish and use this notice accordingly.

Best regards, Werner Rusterholz, Jona, Switzerland, [rusterholz@active.ch](mailto:rusterholz@active.ch)

## Soy's Anti-Nutrient Action

Dear Duncan: The soy disinformation story is the most important dietary info I have read to date ["Tragedy and Hype, 7/03].

The anti-nutrient advice my family have received over 30 years is staggering. The soy baby formula prescribed for one child may well be the cause of his immune system, behavioural and learning difficulties in the 1970s.

Some years ago, I fell into the CFS/asthma roundabout. I was very low in zinc, iron, B12, with clumped red cells, etc. Holistic assistance did a good job, but I still had the problem absorbing zinc. I stopped using soy milk while overseas last year, but restarted some time after my return. My energy started to "creep down", and blood screening with tests showed the restart of the zinc and red cells story, but why? Since "Tragedy and Hype", I have stopped my soy intake and my energy is back. I anticipate a clear blood screening soon!

By the way, I rang my favourite (Australian) organic soy milk company. They use steel tanks, so at least I wasn't getting aluminium poisoning!

Before my "accelerated brain ageing" from the isoflavones catches up, I implore all readers who talk with naturopaths, health food stores, doctors and parents to give them a copy of "Tragedy and Hype" as a gift to future generations (and this one).

Peace be with you.

Hugh Simmons, New South Wales, Australia

PS: Can anyone specifically state that organic rice milk is safe, or is this another chemical time bomb with group action potential?

**"SON OF STAR WARS"  
COMING TO UK/EUROPE**

Following a series of secret meetings over the past six weeks in London, Washington and Brussels—involving members of the Clinton Administration and the British Cabinet, senior staff officers from the Pentagon and the British Ministry of Defence, senior management from the US National Security Agency and British GCHQ, and representatives from NATO (on a strictly "need-to-know" basis)—Washington has been given permission to proceed with the first British stage of the "Son of Star Wars" program. This involves changes in computer software at the US satellite base at Fylingdales in North Yorkshire (*Intelligence*, no. 112, p. 26).

Eventually the US\$50 billion national missile protective shield, designed to provide early warning of a rogue nuclear missile attack against the US, will involve a massive extension to Menwith Hill, near Harrogate, and an arsenal of 200 "interceptors" set up in Britain, Denmark and the USA (North Dakota and Alaska).

Although the system is not due to be tested until mid-May, President Bill Clinton has been under increasing pressure from the Republican-dominated Congress to agree to develop the technology.



Pointing out that London could not be expected to "turn down a request from our closest ally to change its computer software", a UK Cabinet spokesperson claimed that Prime Minister Tony Blair had "acted as a bridge between Europe and the US" in persuading the Pentagon to "share information about the missile shield technology" with its NATO allies.

Exactly what the Europeans are to do with the data, which is bound to be heavily edited, wasn't mentioned in the statement. (*Source: Intelligence (France)*, #115, 10 April 2000, [www.blythe.org/Intelligence](http://www.blythe.org/Intelligence))

**CASE AGAINST DR HULDA  
CLARK DISMISSED**

Charges laid against Hulda Regehr Clark, PhD, ND, have been dismissed. Dr Clark was arrested in September 1999 and charged with practising medicine without a licence—a felony that can be punished with up to eight years in prison (see *Global News* 7/01).

Dr Clark was released on bail a few weeks later, but the uncertainty over the outcome of her trial was a heavy burden on the 71-year-old researcher from San Diego, CA. Her enemies wanted to see her locked up behind bars. To the established medical interests, Dr Clark's workable therapy against cancer is a huge threat. But now the charges have been dismissed.

David Amrein, President of the Dr Clark Research Association, has expressed his thanks to everyone who contributed to the legal fund or helped in other ways. He says the real fight is far from being over—the fight for individual freedom of choice in medical matters.

(*Source: Dr Clark Research Association*, 18 April 2000, e-mail [info@drclark.net](mailto:info@drclark.net), website [www.drclark.net](http://www.drclark.net))

**DRUG MAKERS DON'T FINISH  
STUDIES AFTER LICENSURE**

Drug makers have consistently failed to conduct studies of their products after they are put on the market—studies that were often required by the FDA as a condition for a drug's approval, according to the consumer watchdog Public Citizen.

Data that the group obtained from the FDA through the Freedom of Information Act shows that from 1990 to 1994, 88 new drugs were approved, based in part on the manufacturers' commitment to do such studies (known as postmarketing or phase-four studies). Just 13% of the manufacturers of these drugs had completed the studies as of December 1999, the group found.

"This means that for at least five and as long as 10 years after drug approval, all of the studies for 87% of these drugs had not been completed," says Larry Sasich, PharmD, MPH, a spokesperson for Public Citizen, the group founded by consumer advocate Ralph Nader.

(*Sources: <http://my.webmd.com/content/article/1728.56650>, via Sheri Nakken, AVN@egroups.com, 18 April 2000*)



## SUPERVIRUSES: THE NEXT DIGITAL THREAT

The "Love Bug" has given us just a taste of what could be coming. The virus caused billions of dollars' worth of damage—more than any other virus or hacking attack since the dawn of cyberhistory.

It lay dormant for nearly a week before surfacing on computers in Hong Kong. The message, seemingly sent by someone known to the computer user, said "ILOVEYOU" and had an attachment which appeared to be a love letter.

Launching the attachment allowed a program to invade the computer, which not only sent copies of the e-mail to all the addresses listed on the machine but also *scooped up all the passwords it could find and sent them back to the creator of the bug.* [Emphasis added. Ed.]

Anyone from the Pentagon to the House of Commons to New Zealand universities was hit. An estimated 20 per cent of the world's computers were affected. It could have been much worse.

In November 1999, the "Bubbleboy" virus broke the longstanding rule that you have to open an e-mail attachment to become infected. By the time it was in your in-box, it was already too late. Thankfully, Bubbleboy did not have a "destructive payload" and so did little damage. Importantly, however, few took much notice of the quantum leap that it represented. In April 1999, a virus called "Chernobyl" was activated in hundreds of thousands of computers in Asia and the Middle East. Not only did it wipe out stored data, it destroyed BIOS—the basic instructions that tell a machine how to start. Another quantum leap.

Virus writers are now able to combine the destructiveness of Chernobyl with the invasiveness of Bubbleboy and the speed of the Love Bug—and create a supervirus.

According to experts, at least 50 such superviruses have already been detected on the Internet. None has yet been launched at the public. Some may not work; some may be shot down by existing virus defences; some might get through. And that is the nightmare scenario.

A hacker known as "Dark Tangent", who heads a group which advises big business on their security, said the only surprise is that a "supervirus hasn't happened yet".

(Source: The Observer, UK, [www.guardian.co.uk](http://www.guardian.co.uk), 7 May 2000)

## DRIVING WITH BIG BROTHER

In Australia, plans are afoot to compulsorily equip all motor vehicles with electronic sender units which will be read by global positioning system (GPS) satellites.

The Victorian Government expects the satellite detection system to be fully operational by 2001.

All registered vehicles will be required to carry a microchip sender unit, which instantly records a vehicle's position and speed. Heavy fines and even vehicle confiscation will apply to those with missing or inoperable sender units.

The government is well advanced in its plan to link Melbourne's new E-tag free-way tolling system into the speed detection net. The E-tag tolling system operates via a number of overhead gantries on major arterial freeways. These gantries detect a vehicle's E-tag signal as it passes underneath, directly debiting the driver's E-tag account to pay the toll. The gantries are also used to calculate the vehicle's speed.

No doubt the Victorian Government will be pleased at President Clinton's recent announcement to make military-level GPS satellite data—which is 10 times more accurate than before—available to all.

(Source: Australian Motorcycle News, vol. 49, no. 18, 31 March 2000)

**ISPs TO BE 'HARDWIRED' TO MI5's INTERNET SPYING CENTRE**  
MI5 is building a new £25m e-mail surveillance centre which will have the power to monitor all e-mail and

Internet messages sent and received in Britain. The UK Government is to require Internet service providers (ISPs) to have "hardwire" links to the new computer facility so that messages can be traced across the Internet.

The security service and the police will still need Home Office permission to search Internet traffic, but they can also apply for general warrants that would enable them to intercept communications for a company or an organisation.

The new computer centre, codenamed GTAC (government technical assistance centre)—which will be up and running by the end of the year inside MI5's London headquarters—has provoked concern among civil liberties groups.

"With this facility, the government can track every website that a person visits, without a warrant, giving rise to a culture of suspicion by association," said Caspar Bowden, director of the Foundation for Information Policy Research.

The government already has powers to tap phone lines linking computers, but the growth of the Internet has made it impossible to read all material. By requiring service providers to install cables that will download material to MI5, the government will have the technical capability to read everything that passes over the Internet.

The new spying centre will decode messages that have been encrypted. Under new powers due to come into force this (northern) summer, police will be able to require individuals and companies to hand

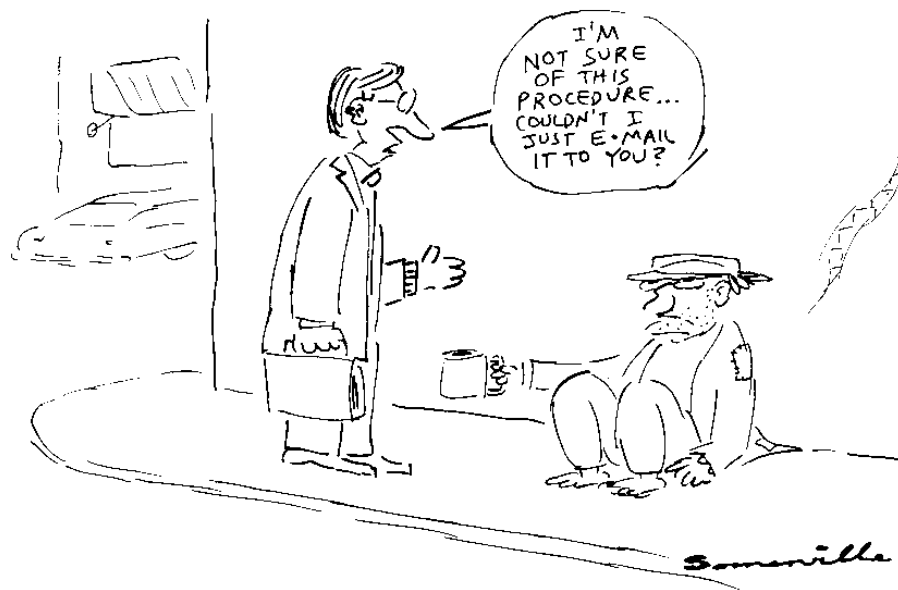

over computer "keys"—special codes that unlock scrambled messages.

"The arrival of this spy centre means that Big Brother is finally here," said Norman Baker, Liberal Democrat MP for Lewes. "The balance between the state and individual privacy has swung too far in favour of the state."

(Source: The Sunday Times, UK, 30 April 2000, [www.sunday-times.co.uk](http://www.sunday-times.co.uk))

## PROZAC – A PRESCRIPTION FOR VIOLENCE

Prozac, the world's best-selling anti-depressant, is being blamed for turning healthy, placid people violent. It is thought to have led to crimes that include murder.

In the first clinical trial of its kind, Dr David Healy, director of the North Wales Department of Psychological Medicine at the University of Wales, gave Prozac to a volunteer group of mentally healthy adults and found that even *their* behaviour was affected. "We can make healthy volunteers belligerent, fearful, suicidal, and even pose a risk to others," he said.

The study is the strongest vindication yet of mental health campaigners who claim that dozens of people have been wrongly imprisoned because of the effects Prozac has had on their behaviour. In the United States, school shootings have been linked to number of children given Prozac and other anti-depressants.

In February, a judge in Connecticut acquitted a bank robber who blamed his behaviour on Prozac. In what is thought to

be the first ruling of its kind, Superior Court Judge Richard Arnold freed Christopher DeAngelo, a 28-year-old insurance agent, because the defendant was unable to appreciate that his actions were wrong. Defence lawyer John Williams said: "This was someone who was driven to commit crimes because of prescription drugs."

Meanwhile, doctors in the USA are prescribing Prozac and Ritalin to an ever-increasing number of children. In 1995, over 150,000 children—just in the age group of two to four years—were on Prozac-type drugs. This figure is likely to have tripled since then.

(Sources: Guardian Weekly, 2–8 March 2000; The Observer, 12 March 2000)

## MODERN HUMANS NOT RELATED TO NEANDERTHALS

An analysis of DNA extracted from the A ribs of a 29,000-year-old Neanderthal infant buried in a cave in southern Russia shows that modern humans are not related to Neanderthals.

The infant would have been among the last of the Neanderthals. Exactly what happened to them is a mystery. Various theories suggest they were killed off, lost out to competitors or were simply absorbed by modern humans.

The study, led by William Goodwin of Glasgow University, is also important because it verifies the findings of the first analysis of Neanderthal DNA in 1997. The DNA sequence from the infant is very

similar to the specimen from the Feldhofer Cave in Germany—proving that both are genuinely Neanderthal and that there was little diversity among them.

"The fact that these two Neanderthals are closely related and not related to modern humans implies that they don't have the diversity to encompass a modern human gene pool," said Goodwin.

(Source: Reuters, 27 March 2000)

## INCENTIVES FOR DOCTORS MAY AFFECT YOUR HEALTH

It usually begins in medical school. Students receive drug company pens, clocks and coffee mugs. As they become doctors, the gifts they receive often increase in value: drug samples, tickets to ball games, dinners for them and their families, all-expenses-paid trips to ski or beach resorts to "consult" with drug company representatives.

It is all part of an intense marketing effort. Each drug company tries to convince doctors of the benefits of its medications, so the doctors, in turn, might prescribe them to you.

By one published estimate, drug companies last year spent an average of US\$13,000 on every physician in the USA, which adds up to more than \$8 billion. Drug companies now employ 70,000 sales representatives, which means one sales representative for every nine doctors.

A recent analysis of 16 different studies showed that doctors courted by drug companies were more likely to engage in "non-rational" prescribing. In other words, they were more likely to order a drug that was more expensive or less effective than what the patient actually needed.

The doctors were also more likely—in some cases, 20 times more likely—to ask a hospital to add the company's drug to the hospital inventory, even though most of the requested drugs "presented little or no therapeutic advantage".

(Source: ABC News, USA, 17 February 2000, <http://abcnews.go.com/onair>)

## LOCKERBIE PRIME WITNESS PREVENTED FROM TESTIFYING

Former US Defense Intelligence Agency (DIA) operative Lester Coleman was recently incarcerated in a Kentucky prison on charges he alleges are false—yet another effort by the federal government to silence him. Upon his release, Coleman was remanded into custody once again, this



time by New York Federal Judge Thomas Platt. Coleman is a key witness in the Pan Am 103 trial, currently underway in Camp Zeist, The Netherlands.

Coleman's "crime", according to Judge Platt, is perjury, committed in an affidavit he gave in 1997. His testimony blew the whistle on a massive CIA/DEA drug smuggling operation which facilitated the smuggling of a bomb aboard Flight 103. A bag of heroin aboard the flight, bound for a Drug Enforcement Administration drug sting operation in Chicago, was switched for a bag of explosives. Coleman maintains that this testimony is true, and has attempted to appeal the perjury conviction, claiming that his "guilty" plea was made under extreme duress.

A front-page story that appeared on 16 April in the *Sunday Herald* newspaper in Scotland corroborates Coleman's statements. The story reveals claims made by Roland O'Neill, the Pan Am baggage handler who was in charge of loading luggage onto Flight 103. O'Neill's statements back up long-held suspicions that Palestinian terrorists operating in Germany planted the bomb at the behest of Iran, mirroring Coleman's allegations.

Coleman has led the life of a fugitive ever since co-authoring a book, *The Trail of the Octopus*, based on his knowledge of drug smuggling by various US intelligence agencies. Upon the book's publication, an order for Coleman's arrest was issued by the US Government, primarily on accusations of perjury. He was attacked and viciously beaten shortly before his return to the United States in 1996, then placed in custody on federal charges. His book's release by major publishers has since been successfully suppressed.

Coleman has been subpoenaed to testify at the trial of the two Libyans who have been blamed for the Pan Am 103 bombing. However, his continued imprisonment will effectively prevent his appearance.

Coleman would not be the first person to die because of having inside knowledge on the Pan Am tragedy. Investigative journalist Danny Casolaro was found with his wrists slashed in Martinsburg, West Virginia, in 1991—one week after interviewing Coleman. Former DIA/DEA associates of Coleman, including two Lebanese operatives who knew about the drug sting, have been murdered.

(Source: Rumor Mill News Agency, 19 April 2000, [www.rumormillnews.com](http://www.rumormillnews.com))

## ASPARTAME-RELATED HEALTH PROBLEMS CONTINUE LONG AFTER INGESTION STOPPED

From Betty Martini, Mission Possible

In the last few days I have read discussions about aspartame reactions recurring months after having ceased ingestion of the toxin, and also with detoxifying and losing weight (which you would expect to release poison).

I have mentioned in the past that it is common to have a severe reaction, should you accidentally get the least little bit of NutraSweet or even another toxin. James Bowen, MD, has discussed this with me on several occasions, and since he called tonight I asked if he would dictate some information on the issue so it could be put on the list for all who have had questions.

Please keep in mind that aspartame is not an additive: it is a chemical poison. The best way to understand NutraSweet is to think of it as a minute dose of nerve gas that eradicates brain and nerve functions. Below are Dr Bowen's comments.

"I have come across first-hand reports of a lady doctor who had her medical degree revoked because she spoke on the aspartame issue. Even I have been threatened by insiders from the political camp of aspartame, that they will get my degree revoked.

"This brings up a topic of equal magnitude to the aspartame topic, and directly related to it: polychemical sensitivity syndrome (PCS) or chemical hypersensitivity. Virtually every doctor who has dealt with this problem has had a large group of highly satisfied patients, only to see his career destroyed by medical licensing boards and the medical training establishments. This reflects the sure knowledge that they are destroying people's health with this problem.

"The Persian Gulf syndrome is largely polychemical sensitivity from the massive NutraSweet exposure experienced by our men in combat units in the Persian Gulf. The first investigative reports of the Persian Gulf syndrome noted these facts, only to be followed by reports that these Persian Gulf victims obviously could not have polychemical sensitivity syndrome because such a thing doesn't exist, and nothing the medicine was doing for them was helping. Therefore, they must be chronically unhappy people who couldn't be made happy in any manner.

"This illustrates the highly significant feature of aspartame poisoning: that it is an extreme hypersensitisation agent which is highly reactive with other chemicals, especially toxic ones—like the nerve gas and nitrogen mustard gas our troops were exposed to in the Gulf, when our government tried to destroy the stockpiles of these gases they had previously supplied to Saddam Hussein. This is a very poignant part of the NutraSweet issue, because those who had problems with Nutrasweet will now experience recurrences of those same problems when exposed to even the most minute doses of various toxic agents.

"For example, the government studies of formaldehyde hypersensitivity performed many years ago showed that, once hypersensitised, a person can then react to as little as a billionth of a gram of formaldehyde with a violent health problem of some kind. Back in 1983, when NutraSweet was put on the market for [soda]pop, the allowable amount of formaldehyde in ambient air was 500 parts per billion. Our government has subsequently lowered that tolerance level to 50 parts per billion as an official government environmental standard.

"Yet, the government defends staunchly the marketing of aspartame, which as a formaldehyde poisoning is probably 500 times as potent as straight formaldehyde, causing aggravated formaldehyde poisoning in its victims. And yet the amount you would get from a can of pop greatly exceeds what you would get from inhaled air, even by the old, more lenient standard.

"The reason I feel it's so important to publish this information is that those who have been victimised by aspartame really don't have a good shot at enjoying the health they had before, unless they recognise the problem and know how to deal with it."

— James Bowen, MD, telephone +1 (719) 332 0033

(Source: From Betty Martini, *Mission-Possible-USA@altavista.net*, 16 April 2000. For more information on aspartame, visit the website [www.dorway.com](http://www.dorway.com).)



## MORE PHARMACEUTICAL POLLUTANTS FOUND IN WATERWAYS AND GROUNDWATER IN US & CANADA

by J. Raloff © 2000

Over the past decade, European chemists have been documenting widespread pharmaceutical contamination of their lakes, streams and groundwater. In early April, US and Canadian scientists offered preliminary confirmation that traces of drugs, excreted by people and livestock, similarly pollute American and Canadian waters. They presented their findings at the first major American symposium on pharmaceuticals in water, held as part of the American Chemical Society's Spring national meeting.

Water pollution by drugs "is a newly emerging issue", observes Christian G. Daughton, symposium co-organiser and chief of environmental chemistry at the US Environmental Protection Agency's National Exposure Research Laboratory in Las Vegas, Nevada. By offering a US venue for the meeting "and participation by many European leaders in this field", he hoped to awaken domestic interest and catalyse research on the topic (*Science News*, 21 March 1998, p. 187).

Ironically, Daughton notes, EPA scientists who examined the sludge from a US sewage treatment plant 20 years ago found that the incoming sewage contained excreted aspirin, caffeine and nicotine. Daughton says that the findings were written off as a curiosity and were all but forgotten.

At about the same time, recalls Herman Bouwer of the US Agricultural Research Service in Phoenix, Arizona, the cholesterol-lowering drug clofibrac acid turned up in a groundwater reservoir being tapped to meet the Phoenix community's thirst. The drug had entered with treated sewage which the city had been using to replenish the aquifer.

"At the time," Bouwer recalls, "we didn't pay attention to the finding." It should have been a wake-up call, he now argues, because if clofibrac acid could pass through a sewage treatment plant and percolate through soil unscathed, so could a host of other drugs.

And they do, as new studies show.

Chris Metcalfe of Trent University in Peterborough, Ontario, Canada, reports finding a broad mix of drugs, including anti-cancer agents, psychiatric drugs and anti-inflammatory compounds. "Levels of prescription drugs that we have leaving sewage treatment plants in Canada are sometimes higher than what's being seen in Germany," he says. He explains that many North American cities employ more rudimentary sewage treatment methods than do those in Germany.

Daughton also observes that a million US homes send their essentially untreated sewage directly into the environment.

Two years ago, the symposium's other co-organiser, Thomas

A. Ternes, documented unexpectedly high concentrations of drugs, many of which "measured in parts per billion (ppb)", both in raw sewage and in water leaving treatment plants in Germany. The chemist, who is based at the Institute for Water Research and Water Technology in Wiesbaden, Germany, now finds that these drugs enter groundwater.

Sewage effluent can amount to at least half the water in many of Germany's smaller rivers, Ternes notes. Groundwater fed by streams carrying relatively undiluted effluent can be tainted with 1 ppb of carbamazepine, an anticonvulsive drug. Ternes has also detected similar amounts of the anti-inflammatory drug diclofenac, and up to 2.4 ppb of iodine-based drugs used to improve contrast in X-rays.

Because people discard their excess drugs, the town dump can also be a source of pharmaceutical pollution. Under one landfill,

Ternes found groundwater tainted with 12 ppb of clofibrac acid and 1 ppb of phenazone, an analgesic. The latter medication also turned up in groundwater—"but at far higher concentrations"—under a leaking dump in Zagreb, Croatia, notes Marijan Ahel of the Rudjer Boskovic Institute in Zagreb. Some of his water samples had the drug at as much as 50 times the concentration detected by Ternes.

In the United States, federal scientists recently began probing another source of drug pollution: large feedlots for livestock. An estimated 40 per cent of the antibiotics produced in the United States is fed to livestock as growth enhancers.

Geochemist Mike Meyer, of the US Geological Survey in Raleigh, North Carolina, and his colleagues have begun looking for antibiotics in hog-waste lagoons. Three drugs frequently show up, one in concentrations approaching one part per million. The same three antibiotics, which are also prescribed for people, often appear in local waters—though, as Meyer notes, "usually only at one-tenth to one-hundredth the concentrations in the lagoons". "So, it appears we're get-

ting transport of these antibiotics into surface and ground waters," he told *Science News*.

Meyer says that colleagues at the Centers for Disease Control and Prevention in Atlanta, Georgia, have begun sampling bacteria from the tainted waters to investigate their responses to the antibiotics present. Their findings could begin to resolve a long-standing question: what is the contribution, if any, of livestock to potentially dangerous reservoirs of bacteria resistant to common antibiotics (*Science News*, 5 June 1999, p. 356)?

Traces of drugs are sometimes making it all the way into tap water. Thomas Heberer, of the Technical University of Berlin, reported finding traces of at least three pharmaceuticals in samples from his home tap. The concentrations, however, were near the limits of detection—a few parts per trillion. Moreover, he

**The symposium's scientists note that, to date, few if any toxicological studies have evaluated risks posed by chronic exposure to trace concentrations of pharmaceutical drugs.**

found that running this water through an activated carbon filter removed all vestiges of the drugs.

Ternes's studies confirm that two disinfection agents, "activated carbon and ozone", which are used in many European drinking-water plants, generally remove any traces of drugs. It's because these relatively costly technologies aren't employed for treating sewage, he notes, that a large share of the drugs flushed down toilets can reach open waters.

The symposium's scientists note that, to date, few if any toxicological studies have evaluated risks posed by chronic exposure to trace concentrations of pharmaceutical drugs. However, most of the participants suspect that the biggest risks face aquatic life, which may be bathed from cradle to grave in a solution of drugs of increasing concentration and potency.

David Epel, of Stanford University's Hopkins Marine Station in Pacific Grove, California, is especially concerned about new drugs called "efflux-pump inhibitors". These drugs, he says, are designed to keep microbes from ejecting the antibiotics intended to slay them, and also impede the cellular pumps that nearly all animals use to get rid of toxicants (*Science News*, 12 February 2000, p. 110).

Epel is concerned that if pump-inhibiting drugs enter the aquatic environment, they might render wildlife vulnerable to concentrations of pollution that had previously been innocuous.

(Source: By J. Raloff, *Science News*, vol. 157, no. 14, 1 April 2000, p. 212, website [www.sciencenews.org/20000401/fob1.asp](http://www.sciencenews.org/20000401/fob1.asp), posted 8 April 2000)

## PROMIS SOFTWARE: A LINK TO THE ECHELON SPYING SYSTEM?

by Kenn Thomas © 2000

The research of Danny Casolaro, the writer who died in Martinsburg, West Virginia, in August 1991 while investigating an intelligence cabal called The Octopus, continues to contextualise current events in ways that the mainstream media fail at daily. For instance, it seems more than likely that the vast spy satellite system known as *Echelon*, now emerging as a major topic in international public debate about the surveillance society,

relies on some permutation of the PROMIS software—a system that was crucial to Casolaro's research.

PROMIS was stolen from the Inslaw company by Ed Meese cronies in the US Justice Department under Ronald Reagan. It became infamous for its "back door", allowing the Octopus cronies to spy on clients who had bought PROMIS illegally.

In addition to high-resolution visual monitoring, the *Echelon* satellites—maintained and utilised by such US intelligence groups as the National Security Agency (NSA) and the National

Reconnaissance Office (NRO)—monitor phone calls and e-mail transmissions for key words like "bomb" and "assassination" that ostensibly might expose terrorists. A growing body of independent researchers, however, have come to understand that the system has been used for industrial espionage and for the tracking of private citizens and political dissidents. The *Echelon* satellites use advanced software-hardware technology that mystifies researchers. Amidst official denials that it can be done at all,

these researchers are beginning to focus on the real question of *how* it can be done. The answer to that may rest with PROMIS and Danny Casolaro's research.

The development and use of Inslaw's PROMIS, to the extent of Casolaro's research, are detailed in *The Octopus: Secret Government and the Death of Danny Casolaro*, the book I co-authored with Jim Keith. However, the permutations and evolutionary mutations of PROMIS have since become the gist of much further speculation and research. At the start of the Clinton Administration, for instance, PROMIS illuminated the death of White House aide Vince Foster with suggestion that it has been introduced into international banking systems. According to one theory, Foster's Swiss bank accounts were made vulnerable in this way and may have led to his suicide or murder.

... it seems more than likely that the vast spy satellite system known as *Echelon*, now emerging as a major topic in international public debate about the surveillance society, relies on some permutation of the PROMIS software ...



PROMIS came up again on the periphery after the Heaven's Gate cult incident, when it became apparent that the last significant news from the area where the cult lived, in Rancho Santa Fe near San Diego, involved the murders of Ian Spiro and his family. Spiro was a British intelligence spook who had been helping Danny Casolaro's main informant, Michael Riconosciuto—the creator of the PROMIS back door.

Even the death of Diana, Princess of Wales has a tentacle reaching back to PROMIS in the person of Adnan Khashoggi, Dodi Fayed's uncle. Khashoggi's signature appeared on a document that had Casolaro excited on the day that he died. That very night, he was due to meet with someone named "Ibrahim" who would have shed more light on Khashoggi's role in the Iran-Contra scandal. Khashoggi is a notorious arms merchant responsible for developing supra-legal contracts that sustain Middle East defence and oil industry corruption.

Those politics certainly played a role in whatever happened to Diana and Dodi in the Pont de l'Alma tunnel. They came into play again with the tragic death of my *Octopus* co-author, Jim Keith, in September 1999. Keith died of a blood clot after reluctantly going into a Reno, Nevada, hospital for minor knee surgery. Rumours were rife that the odd death had to do with Keith's reporting on the possibility that Diana was pregnant at the time of her death. In a column for the website Nitro News (now defunct), Keith said he would name the physician who told Diana she was pregnant. Word had it that Keith was killed before he could name that name. A thorough investigation of Keith's death—a tremendous loss to the conspiracy information underground—has yet to be made.

Of paramount interest to the desktop conspiracy student, however, is the ongoing development of PROMIS-like back doors that have been popping up to spy on average personal-computer users. These are the most likely suspects as somehow being linked to the *Echelon* system.

Rumour had it that when the original versions of Windows 95 appeared, they contained a back door that surreptitiously read the user's hard drive and reported it back to someone—Bill Gates? *Echelon*? In the trans-global corporate state, the distinction hardly needs to be made. This rumour came with the story that pressing some key combination during the opening "clouds" sequence of Windows 95 brought to the screen a photograph of a prized Palamino owned by Gates. The first draft of Casolaro's book on the *Octopus* was entitled "Behold, A Pale Horse". The "back door" feature ostensibly was removed from later versions of Windows, and today the software has a voluntary registration that does the same thing, only with the consent of the spied-upon. Presently, there is no indication of how it works with the pre-installed software often bought by many non-computer-savvy people.

The standard consumer computer and its Internet connection may contain the means by which *Echelon* spies on the world. Last January, a "glitch" in the protocol for removing phone listings from the Yahoo! site gave private address listings when phone numbers were punched in. Glitches found in the Netscape browser in 1995—one that allowed Netscape to extract the history of a user's session, and another that subverted encryption/decryption operations—won \$1,000 from a bug bounty hunter group for two young hackers in Australia and San Francisco, USA. Perhaps it is not surprising that two years later, presumably long after it fixed these other bugs, Netscape awarded another \$1,000 plus a T-shirt to Danish software company Cabocomm when it discovered another glitch. This one allowed a website operator to read anything stored on the hard drive of a computer logged on to the site. Implications of a more advanced technology no doubt employed by *Echelon* are onerous.

Encryption security and the "Clipper chip"—a "front door" strategy for keeping tabs on the Internet—served as issues with the general public in preparation for the coming *Echelon* debate. Philip Zimmerman used a public domain algorithm to create the Pretty Good Privacy encryption software, and he publicised it freely, bringing that protection to the masses. However, even cybernerds have trouble dealing with PROMIS/*Echelon* possibilities that may not even exist, as some have argued.

Daniel Brandt, producer of CIABase/NameBase, a renowned data engine on intelligence literature and personalities, argues: "...a 'back door' to get around password protection is easy for any programmer... [but] you still need physical access to the computer, either through a direct-connect terminal or a remote terminal through the phone lines, in order to utilise a back door. [It is difficult] to believe that foreigners allow technicians from another country to install new computer systems in the heart of their intelligence establishments, and don't even think to secure physical access to the system before they start entering their precious data...claims that PROMIS...can suck in every other database on Earth,

such as those used by utility companies, and correlate everything automatically...needlessly discredit [whistleblowers] by their own high-tech gullibility."

Bill Hamilton, the owner of Inslaw—the company which originally developed PROMIS—maintains that the software could run on "any UNIX machine, Hewlett Packard UNIX, RISC 6000, AT&T, AS400, under its own operating system, and on mainframes under MVS"; that it was comprised of 88 program modules; and that the source code, replete with the Inslaw name throughout the code commentary, was kept by any government which had it. When asked how a foreign country could modify the source code without discovering the back door, Hamilton was

**The standard  
consumer computer  
and its Internet  
connection  
may contain the  
means by which  
*Echelon* spies on  
the world.**

## deBriefings

explicit about the connection to *Echelon*: "I don't know what's meant by the 'back door'. What we've been told is that not only the software was sold, but computers with extra chips... What the chips do, we've been told—the extra chips—is to broadcast the data inside PROMIS to satellites owned by the NSA...but we don't know enough about it as they've never shared anything with us." This possibility addresses Daniel Brandt's objection that physical access is required for a back door to work.

Writer J. Orlin Grabbe elaborated on the idea in a recent column: "Since intelligence computers are, for security reasons, usually not connected to external networks, the original back door was a broadcast signal. The PROMIS software was often sold in connection with computer hardware (such as a Prime computer) using a specialised chip. The chip would broadcast the contents of the existing database to monitoring vans or collection satellites, using digital spread spectrum techniques whenever the software was run. Spread spectrum techniques offer a way to mask, or disguise, a signal by making it appear as 'noise' with respect to another signal. For example, one may communicate covertly on the same spectrum as a local TV broadcast signal. From the point of view of a TV receiver, the covert communication appears as noise and is filtered out. From the point of view of the covert channel, the TV signal appears as noise. In the case of the PROMIS broadcast channel, the signal was disguised as ordinary computer noise..." Thereafter, unfortunately, Grabbe's discussion—which includes correspondence with PROMIS architect Michael Riconosciuto—becomes more technical than is useful to a non-technical person's understanding of how PROMIS works.



It is the same with remarks about further criticism from Daniel Brandt, penned by Riconosciuto, which have circulated among conspiracy researchers. For example, Riconosciuto states: "As far as the requirement of special hardware to transmit data [is concerned] ...the example that Mr Brandt uses, that software can alone supply various combinations of ones and zeros to the CPU, only shows Mr Brandt's lack of knowledge of what Walsh functions are... Brandt's comments start out that computers radiate electromagnetic energy unless they are shielded. This is an insult. Anybody who has been around knows what Van Eyck backing is (decoding from a distance what is displayed on a CRT screen). An active phased array antenna is superfluous at the short distances he describes. A high-performance surveillance receiver such as those made for Watkins Johnson corporation, Stoddarts/Singer or Fairchild, will do the job quite nicely with a standard biconical antenna... Brandt will find that if an arbitrarily small section of a sine function is known, the function is known everywhere. This feature of the sine wave is referenced to sinusoidal waves that transmit information at a net rate of zero!... Mr Brandt's statement that software can only provide combinations of 1s and 0s to the CPU totally misses the point that Walsh functions are inherently suited to binary operations. This is one reason why such tight, compact code can be written around operations with Walsh functions. This is why it is so difficult to find these routines and differentiate them from routines normally used at the RTL (register transfer logic) level. This is at a level of programming that is one jump lower than machine language."

Which, again, is several steps above the average person's ability to follow these technical possibilities. It seems almost inarguable that the PROMIS software has properties and applications compatible with the *Echelon* military-industrial spy satellite system.

In addition to being a bell-ringer for the dangers PROMIS poses to the average person, Casolaro—and perhaps Jim Keith—died in part trying to uncover its other, more sinister capacities. *Echelon* has almost become the ultimate expression of the global conspiracy culture, and certainly the most obvious example of the encroaching surveillance society.

The developing interest in and protest over *Echelon's* existence is the best legacy of those who made sacrifices in trying to understand the role of The Octopus and the possibilities of PROMIS. This part of the story is still unfolding.

### About the Author:

Kenn Thomas is co-author of *The Octopus: Secret Government and the Death of Danny Casolaro* (Feral House) and author of the prequel, *Maury Island UFO* (IllumiNet Press). He has edited two volumes of *Cyberculture Counterconspiracy* (Book Tree) (see review this issue), and produced five other books on conspiracy topics, including *NASA, Nazis & JFK*. He publishes the conspiracy magazine *Steamshovel Press*. (For a copy of the current issue, send USD\$6 [USD\$8 foreign]; for a four-issue subscription, send USD\$23 [USD\$28 foreign] to: POB 23715, St Louis, MO 63121, USA.) *Steamshovel Press* maintains a website, [www.steamshovelpress.com](http://www.steamshovelpress.com). For further information, e-mail Kenn Thomas at [kenthomas@umsl.edu](mailto:kenthomas@umsl.edu).

## MMR VACCINE LINK TO AUTISM NOW CLEARER

by Lorraine Fraser © 2000

***Strong evidence for a link between MMR (mumps-measles-rubella) vaccination and autism and bowel disease in children was announced by UK doctors in February 1998. In a further study, led by Professor John O'Leary, the measles virus was found in the intestines of 24 out of 25 children who developed autistic enterocolitis after an apparently healthy infancy.***

**S**peaking under oath before a hearing of the powerful US Congress Committee on Government Reform, Professor John O'Leary told how his state-of-the-art laboratory had identified the measles virus—something which certainly should not have been there—in samples taken from the intestines of no fewer than 24 of the 25 patients studied.

The findings of his vitally important study, reported for the first time on 6 April at the congressional hearing on autism, provide compelling new evidence linking measles virus infection and this terrible affliction. And they raise urgent new concerns over the safety of MMR vaccine—the combined mumps, measles and rubella vaccination given routinely to hundreds of thousands of children in Britain (and around the world) every year.

It is more than five years since Rosemary Kessick, desperate to find out why her previously healthy baby had developed terrible bowel problems and was suddenly behaving uncontrollably, first sought out the man who provided Professor O'Leary with those crucial biopsies from the autistic children. She approached Dr Andrew Wakefield, an honorary consultant gastroenterologist at the Royal Free Hospital in London and an acclaimed researcher on inflammatory bowel disease.

Dr Wakefield had never before seen a child like William, whose autism had descended on him almost overnight. When he examined the lining of William's bowel with a fibre-optic camera, he was stunned to discover an inexplicable abnormality. In February 1998, having seen 11 more patients with identical symptoms, he dared to suggest that parents such as Rosemary, who believe their children developed autism after receiving the MMR vaccine, should now be taken seriously.

In a scientific paper published in the leading medical journal *The Lancet*, Dr Wakefield and his colleagues described how they discovered this same pattern of inflammation of the bowel—which they believed was part of a new disease, autistic enterocolitis—in all 12 children. They reported that parents of eight of the children said that the youngsters' behaviour began to deteriorate after their MMR vaccinations. While there was no direct evidence of a link, Dr Wakefield said it must be properly investigated. He stressed he was not anti-vaccine and only wanted safe vaccination programs for children.

But within the medical establishment there is no greater heresy than to question the safety of a childhood vaccine. Dr Wakefield was quickly accused of undermining parents' confidence in MMR and of putting children's lives at risk because large numbers of parents had decided to shun the vaccine. From that day on, he was ostracised by the medical community. His meticulous studies on

the 12 children—and subsequently, hundreds more like them—were ignored by the UK Government and dismissed by "experts" from the Medical Research Council. He was ordered by his bosses at University College London not to speak to the Press.

Now, says Professor O'Leary, a leading independent pathologist from the Republic of Ireland, the new evidence from his laboratory must change all that. He is doubly concerned because another independent research group in Japan has also found the measles virus in the blood of three of Dr Wakefield's patients—and they say the genetic fingerprint is "consistent" with the strain used in MMR vaccine; so further studies are now imperative.

"The findings that I presented to Congress," said Professor O'Leary, "are the results of independent work carried out by my laboratory on material referred to us by Andrew Wakefield. The material that was given to us was sent in a blinded fashion. We did not know the name of the patients, the diagnosis or age before our tests were completed. There was no bias in terms of changing diagnosis or changing results to suit a particular hypothesis."

He said that of the 25 children with autistic enterocolitis whom his laboratory screened, 24 harboured the measles genetic fingerprint. Only one of the 15 control-group children—those who do not have autism—contained the virus.

"That is 96 per cent compared with 6.6 per cent, which is highly statistically significant and implies an association between the measles virus and this disease," said Professor O'Leary. "Measles virus is present in the gut of these children. It shouldn't be there. The next question is to find out what it is doing there, and there needs to be a full investigation of this with proper funding."

Parents in the UK came under enormous pressure from health visitors and GPs to have their children vaccinated

with MMR, with some families thrown off doctors' medical lists for refusing. The Government blocked the import of measles-only vaccine last year. Parents who want the single vaccine are forced to go overseas. If measles virus infection—from whatever source—is confirmed to be causing the chronic bowel changes and brain damage in at least this group of autistic children, it may be possible to find a treatment. Indeed, many parents have found that a strict diet can help their children.

The UK Department of Health has poured scorn on Professor O'Leary's study, yet, at the beginning of April, the Medical Research Council announced a massive survey of two million people across the UK, which is aimed at finding out more about autism and which would "be able to examine any possible association between autism and the MMR vaccine". The potential importance of Professor O'Leary's results will not be lost on solicitors for some 200 children—large numbers of them autistic—who are already suing the makers of MMR vaccine.

Professor O'Leary, who has now decided to widen his collaboration with Dr Wakefield, commented: "The time now is for real research. We need to work out what is going on."

For the hundreds of parents like Rosemary Kessick, that research cannot be done soon enough.

(Source: The Mail on Sunday, UK, 9 April 2000)

**The findings raise urgent new concerns over the safety of MMR vaccine—the combined mumps, measles and rubella vaccination given routinely to hundreds of thousands of children every year.**



# PROJECT CENSORED

## THE MOST UNDER-COVERED NEWS IN AMERICA

*According to the Project Censored voting team, these are last year's top 25 news stories which should have been reported by the media in a big way, but weren't.*

Sonoma State University's Project Censored has released its latest list of the top 25 most under-covered news stories in the United States—as it has been doing for the past 24 years. Media students and staff screened several thousand stories from late 1998 through 1999, and selected 500 to be evaluated by faculty and community experts. The top 200 stories were then researched for national mainstream coverage by the Media Censorship class, and a final collective vote of all students, staff and faculty was taken in early November 1999. Lastly, the top 25 stories were ranked by Project Censored's national judges.

### 1. Multinational Corporations Profit from International Brutality

In the name of commerce, huge multinational corporations collaborate with repressive governments and, in the process, support significant human rights violations. Corporations often argue that their presence and investment will improve human rights. This practice is referred to as "constructive engagement".

Major international energy corporations such as Mobil, Exxon, Enron and Unocal have engaged in major business ventures in countries known as major human rights violators. Major US governmental grants, as well as corporate capital investment, have funded the suppression of media, political opposition and personal rights in Turkmenistan, India and Burma. The myth of "constructive engagement" has failed to improve human rights, and yet has been endorsed both by international corporations and the US Government.

Since the release of this information, BP-Amoco and Statoil have taken positive steps towards addressing human rights issues. Programs are being developed in the US and abroad to deal with the conduct of energy companies globally.

*Source: Arvind Ganesan (ganessa@hrw.org), "Corporation Crackdowns: Business Backs Brutality", Dollars and Sense, May/June 1999.*

### 2. Pharmaceutical Companies Put Profits Before Need

Multinational pharmaceutical companies focus their research and development on high-profile, profit-making drugs like Viagra instead of developing cures for life-threatening diseases in poorer countries. Viagra earned more than one billion dollars in its first year, for instance. Though representatives of the Pharmaceutical Research and Manufacturers of America claim that some funds are directed towards eliminating tropical diseases, neither they nor individual firms are willing to provide statistics.

Research into Third World tropical diseases is not being extensively considered or produced. A recent and effective medicine for African sleeping sickness was pulled from production, while older remedies are no longer available because they are not needed in the US. AIDS continues to receive the most attention in the Third World, mainly because the disease also remains a threat to the First World.

Since the release of this story, Doctors Without Borders won the Nobel Prize and announced an international campaign to increase access to key drugs.

*Source: Ken Silverstein (ksilverstein@erols.com), "Millions for Viagra, Pennies for the Poor", The Nation, 19 July 1999.*

### 3. Financially Bloated American Cancer Society Fails to Prevent Cancer

The American Cancer Society (ACS) is growing increasingly wealthy, thanks to donations from the public and funding from surgeons, drug companies and corporations that profit from cancer cures. More than half the funds raised by the ACS go to overheads, salaries and fringe benefits for its executives and other employees, while most direct

compiled by

**Project Censored © 2000**

Sonoma State University  
1801 East Cotati Avenue  
Rohnert Park, CA 94928-3609, USA  
Telephone: +1 (707) 664 2500  
E-mail: censored@sonoma.edu  
Website: www.projectcensored.org

community services are handled by unpaid volunteers. The value of cash reserves and real estate totals over US\$1 billion, yet only 16 per cent of funds go into direct services for cancer victims.

Conflicts of interest affect ACS's approach to cancer prevention. With a philosophy that emphasises faulty lifestyles rather than environmental hazards, the ACS has refused to provide scientific testimony needed for the regulation of occupational and environmental carcinogens. The Board of Trustees includes corporate executives from industries with a vested interest in manufacturing both environmental carcinogens and anti-cancer drugs.

Source: Samuel S. Epstein (epstein@uic.edu), "American Cancer Society: The World's Wealthiest 'Non-profit' Institution", *International Journal of Health Services*, vol. 29, no. 3, 1999.

#### 4. American Sweatshops Sew US Military Uniforms

The US Department of Defense (DoD) has \$1 billion invested in the garment industry, making it the country's 14th largest retail apparel outlet. Lion Apparel contracts with the DoD to produce military uniforms, yet the company's workplace conditions are dismal and remain virtually unregulated by the US Government. Lion employees are mostly women who are paid as little as \$5.50 per hour. According to records obtained by *Mother Jones* through a Freedom of Information request, the Occupational Safety and Health Administration (OSHA) cited Lion Apparel 32 times for safety and health violations in the past 12 years. Employees in a Kentucky plant are subjected to formaldehyde fumes that cause shortness of breath, headaches and skin rashes.

Efforts to unionise workers have failed because, union leaders claim, the company managed to evade a federal law prohibiting the threat of plant closures. The military continues to refuse to sign the garment industry's anti-sweatshop code of conduct.

Despite the coverage provided by this article, the author estimates that there are still 10,000 American women sewing government uniforms, often in unsanitary, unsafe conditions.

Source: Mark Boal, "An American Sweatshop", *Mother Jones*, May/June 1999.

#### 5. Turkey Destroys Kurdish Villages with US Weapons

In 1995, the Clinton Administration recognised that the Turkish Government used American arms in domestic military operations where human rights abuses occurred. In fact, Turkey has forcibly evacuated, levelled and burned more than 3,000 Kurdish villages in the past decade. Most of the atrocities, which have cost over 40,000 lives, took place during Clinton's first term in office.

As an ally of the US through NATO, Turkey receives US weapons from dozens of companies including Hughes, Boeing, Raytheon and General Dynamics. Despite a horrifying Amnesty International report on violent abuse, the State Department passed arms deals with Turkey. The war in Turkey represents the greatest use of US weapons in combat anywhere in the world today.

Source: Kevin McKeirnan (kevinmck@silcom.com), *The Bulletin of Atomic Scientists*, March/April 1999.

#### 6. NATO Defends Private Economic Interests in the Balkans

As a result of NATO's success in the military conflicts of Bosnia and Kosovo, NATO's member nations have been provided with the political and economic opportunities to partake in the exploitation of the significant mineral resources in the Balkans.

In addition, Western multinational corporations are now well positioned to access the lucrative oil refining industry needed at a terminal end of the pipeline, as per the agreement which was formally signed last November by President Clinton and the presidents of four key Caspian-region nations. The proposed pipeline routes will divert oil and gas from the Caspian Sea area to either Mediterranean or Eastern European terminals for export to the Western nations, thus avoiding the competing interests of either Russia or Iran.

Successful re-establishment of NATO's military presence in the Balkans has made real the goal of a leaked 1992 document of a Pentagon plan to preserve NATO as the primary instrument for Western security interests as well as the channel for US influence and participation in European affairs.

Sources: Diana Johnstone (107764.116@compuserve.com), "The Role of Caspian Sea Oil in the Balkan Conflict", *Women Against Military Madness*, November 1998, and *Sonoma County Peace Press*, April/May 1999; Sara Flounders (iacenter@iacenter.org), "Kosovo: It's About the Mines", *Because People Matter*, May/June 1999, reprinted from *Workers World*, 30 July 1998; Pratap Chatterjee (pchatterjee@igc.org), "Caspian Pipe Dreams", *The San Francisco Bay Guardian*, 16 December 1999.

#### 7. US Media Reduce Foreign Coverage

Coverage of foreign news by the US media industry reflects a continuing downward trend, despite evidence that the American public wants more international information.

Pollsters reveal that most Americans rely on television for national and international news. Unfortunately, major network coverage of foreign news is currently seven to 12 per cent and dropping—a sharp contrast to the at least 40

per cent coverage during the heydays of Cronkite, Chancellor and Reynolds.

Coverage in print media is also down in large metro-area news markets. An example is the drop in coverage by the *Indianapolis Star* from 5,100 column inches within a 30-day period in November 1977 to 1,170 column inches in 1997—a 23 per cent drop over those two decades.

Despite a critical examination by the Project for Excellence in Journalism and the continued campaign of the American Society of Newspaper Editors, major market editors seem to continue to focus on the production of a media diet of crime news, celebrity gossip and soft features in an effort to gain more market share and an increase in profit margins.

Source: Peter Arnett (parnett348@aol), "Good-bye World", *American Journalism Review*, November 1998.

**NATO's member nations have been provided with the political and economic opportunities to partake in the exploitation of the significant mineral resources in the Balkans.**

## 8. Planned "Star Wars" Weapons in Space Violate International Treaty

The Outer Space Treaty of 1967 bans the deployment of space weapons of mass destruction. Recently, US Congress ignored the further need for such a treaty and approved the development of the US Military's Space Command Weapons program. This sudden shift of viewpoint coincides with the complete absence of any foreign government competition, and with the increase in the ability of the US to use satellite surveillance effectively in military campaigns. The proposed system is designed to extend control of space far beyond the outer boundaries of the Earth's atmosphere. To prevent deployment of any adversarial country's satellites, the Pentagon is well along in its research and development of an anti-satellite weapons program.

The re-emergence of a "Star Wars" weapon system is echoed in the words of General Joseph Ashly, Commander-in-Chief of the US Space Command: "It's politically sensitive but it's going to happen...we are going to fight from space and we are going to fight into space."

Concerned with the possibility of nuclear contamination of the atmosphere from satellite break-up, the European Space Agency has urged the US to utilise solar power to fuel military space command modules.

Sources: Karl Grossman ([kgrossman@hamptons.com](mailto:kgrossman@hamptons.com)), "US Violates World Law to Militarize Space", Earth Island Journal, Winter/Spring 1999; Bruce K. Gagnon ([globalnet@mindspring.com](mailto:globalnet@mindspring.com)), "Pyramids to the Heavens", Toward Freedom, September/October 1999.

## 9. Louisiana Promotes Toxic Racism

Contained within the boundaries of a 100-mile [161-km] stretch of land between Baton Rouge and New Orleans are seven oil refineries and 175 heavy industrial plants. The area is locally called "Cancer Alley". The Environmental Protection Agency (EPA) reports that the majority of the 23 million pounds of toxic waste released into the air are in two zip-code areas, primarily inhabited by African-Americans.

A 1992 *National Law Journal* investigation found that even when the government enforces the environmental regulations against companies in violation, the fines levied in these areas are significantly lower than those levied in white communities.

Prompted by an increase in public awareness, President Clinton signed an executive order in 1993 to open an investigation into the impact of the petrochemical industry's practices in these communities of colour.

Despite the rhetoric, little has changed amongst the targeted communities. On the contrary, the State of Louisiana has run full-page promotional ads in the *Wall Street Journal*, promising significant incentives for large corporate industries to relocate to the state, and touting the state's passage of tort reform legislation that limits the liability of companies which lose negligence suits and restricts the ability of citizens to file claims against "these protected companies".

Source: Ron Nixon ([ronn@roanoke.com](mailto:ronn@roanoke.com)), "Toxic Gumbo", Southern Exposure, Summer/Fall 1998.

## 10. The US and NATO Deliberately Started the War with Yugoslavia

The US and NATO pushed for war with Yugoslavia by demanding full military occupation of the entire country as a condition of not bombing. Belgrade could not accept the US-drafted two-part Rambouillet ultimatum, not only because it was a thinly veiled plan to detach Kosovo from Serbia, but also because it contained provisions even worse than loss of that historic province—provisions no sovereign country in the world could possibly accept. Unreported in the mainstream media was the fact that when Serbia rejected the treaty it also passed a resolution declaring its willingness to negotiate Kosovo's self-management.

For months, the Serbian Government offered to negotiate. High-level government teams made many trips to Pristina to hold talks with Ibrahim Rugova and other non-violent ethnic Albanians. The Albanians refused to negotiate, for fear of going against the rising rebel movement, the Kosovo Liberation Army (KLA), which was hostile to any compromise and ready to assassinate "traitors" who dealt with Serbs.

Sources: Jason Vest ([ashenden6@aol.com](mailto:ashenden6@aol.com)), "The Real Rambouillet", The Village Voice, 18 May 1999; Seth Ackerman, "Redefining Diplomacy", Extra, July/August 1999 and "What Was the War For?", In These Times, 8 August 1999; Diana Johnstone ([107764.116@compuserve.com](mailto:107764.116@compuserve.com)), "Hawks and Eagles: 'Greater NATO' flies to Aid of 'Greater Albania'", Covert Action Quarterly, Spring-Summer 1999; Amy Goodman (host), Democracy Now, Pacifica Radio Network, 23 April 1999, [www.Pacifica.org](http://www.Pacifica.org).

## 11. America's Largest Nuclear Test Exposed Thousands

Thirty years ago, Amchitka, Alaska, was the site of three large underground nuclear tests, including the most powerful nuclear explosion ever detonated by the United States. Despite claims by the Atomic Energy Commission (AEC) and the Pentagon that the test sites would safely contain the radiation released by the blasts for thousands of years, independent research by Greenpeace and newly released documents from the Department of Energy (DoE) show that the Amchitka tests began to leak almost immediately.

The blast ruptured the crust of the earth, sucking a creek into a brand new aquifer—a radioactive one. Highly radioactive elements and gases poured out of the collapsed test shafts, leached into the groundwater and worked their way into ponds, creeks and the Bering Sea.

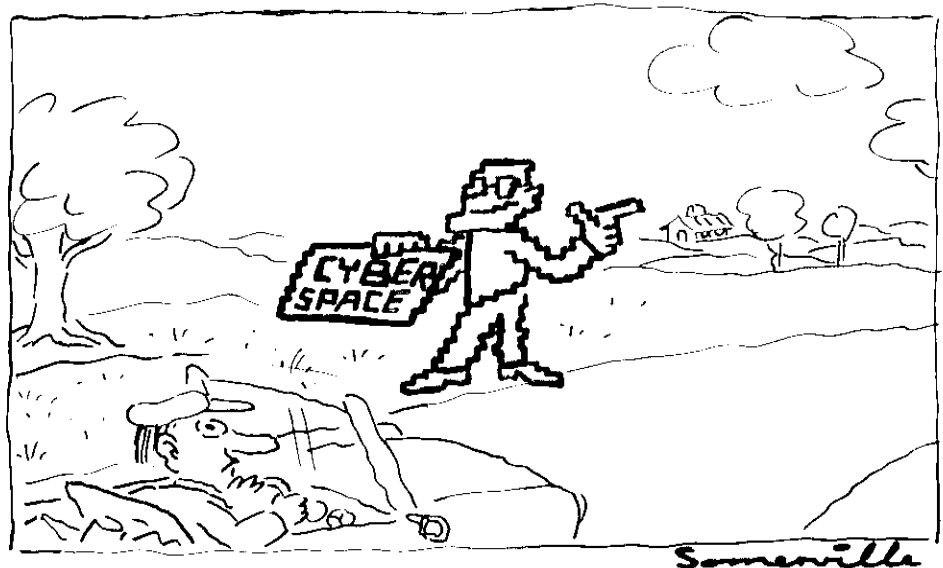

Sources: Alexander Cockburn (alexandercockburn@asis.com) and Jeffrey St Clair (sitka@home.com), "Aftermath of Amchitka", Counterpunch, Summer 1999, Terrain, Fall 1999; Jeffrey St Clair, "Thirty Years After: The Legacy of America's Largest Nuclear Test", In These Times, 8 August 1999.

## 12. Evidence Indicates No Pre-War Genocide in Kosovo and Possible US/KLA Disinformation Plot

According to the *New York Times*, the "turning point" in NATO's decision to wage war on Yugoslavia occurred on 20 January 1999, when US diplomat William Walker led a group of news reporters to discover a so-called Serb massacre of some 45 Albanians in Racak, Kosovo. This story made international headlines and was later used to justify the NATO bombings.

The day before the "massacre", Serb police had a firefight with KLA rebels that was covered by an AP film crew. At the end of day, the village was deserted. William Walker arrived at noon with additional journalists and expressed his outrage at a "genocidal massacre" to the world press.

Walker's story remains shrouded with doubt. "What is disturbing," remarked war correspondent Renaud Girard, "is that the pictures filmed by the AP journalists radically contradict Walker's accusations." Belorussian and Finnish forensic experts were later unable to verify that a massacre had actually occurred at Racak.

Sources: Mark Cook (dejsaba@aol.com), "William Walker: 'Man with a Mission'", Covert Action Quarterly, Spring/Summer 1999; Sam Smith (news@prorev.com), "My Multinational Entity, Right or Wrong", The Progressive Review, June 1999; Pablo Ordaz, "Spanish police and forensic experts have not found proof of genocide in the north of Kosovo", El Pais, 23 September 1999.

## 13. US Agency Seeks to Export Weapons-Grade Plutonium to Russian Organisation with Crime Links

The Washington-based Non-Proliferation Trust (NPT) proposes that the US sell nuclear waste to Russia. NPT's plan would make Russia the world's dumping ground for nuclear waste, including weapons-grade plutonium. NPT's partner in this endeavour is MinAtom, Russia's Ministry of Atomic Energy.

NPT is headed up by Daniel Murphy (former Deputy Director of the CIA), Bruce Demars (former head of the US Navy's nuclear program) and William Webster (former Director of the CIA and FBI). Although NPT is set up as a non-profit organisation, its principals stand to make huge profits from consulting and subcontracting. On the list of potential subcontractors is Halter Marine, in Gulfport, Mississippi—a company to which US Senator Trent Lott has close links.

Yevgeny Adamov, the head of MinAtom, estimates that the operation could produce US\$150 billion in revenue, making it the most lucrative operation in Russia. MinAtom is also alleged to have links to corrupt government officials and the Russian Mob.

Sources: Jeffrey St Clair (sitka@home.com), "Hot Property, Cold Cash: The Plan to Turn Russia into the World's Nuclear Waste Dump", In These Times, 17 October 1999; Jeffrey St Clair and Alexander Cockburn (alexandercockburn@asis.com), "The MinAtom Conspiracy", Counterpunch, vol. 6, no. 16, 16–30 September 1999.

## 14. US Media Ignores Humanitarian Aspects of Famine in North Korea

As a food crisis of staggering proportions develops in North Korea, the US media are focusing on the threat posed by North Korea's continuation of nuclear testing. US media have used the North Korean famine for political propaganda and have failed to cover the huge disaster from an humanitarian perspective. Nowhere is there an outcry like the one developed by media worldwide for Ethiopia.

The German Red Cross estimated there were two million deaths in 1997 due to starvation; the South Korean Buddhists Sharing Movement reported an estimated three million deaths; and the New York Council of Foreign Affairs reported an estimate of one million North Korean deaths due to famine.

Source: Yuh Ji-Yeon (j-yuk@nwu.edu), "Dangerous Communists, Inscrutable Orientals, Starving Masses", Peace Review, June 1999.

## 15. Early Puberty in Girls may be Linked to Chemicals in the Environment and Increases in Breast Cancer

Endocrine disrupters may be responsible for young girls maturing faster, thus creating an increased risk of breast cancer. A University of North Carolina cross-sectional study of girls between the ages of three to 12 years, found that girls are developing pubertal characteristics at younger ages than is suggested by standard paediatrics textbooks.

The study found that, on average, African-American girls begin puberty between eight and nine years of age, and white girls by 10 years of age, which is six months to a year sooner than previous data suggests. Although it is unclear what is causing this early onset of puberty, environmental exposures have been implicated.

Breast cancer risks include the early onset of puberty that is brought on by the release of natural oestrogens in the body. Women who go through puberty early

have longer exposure to these oestrogens and therefore may be at greater risk of developing breast cancer.

Sources: Marcia E. Herman-Giddens, Eric J. Slora, Richard Wasserman, Carlos Bourdony, Manju V. Bhapkar, Fary Koch, Cynthia Hasemeier, "Secondary Sexual Characteristics and Menses in Young Girls Seen in Office Practice: A Study from the Pediatric Research in Office Settings Network", Pediatrics, vol. 11, no. 3, December 1998.

## 16. Media Distort Debate on Affirmative Action

The US media oversimplified the debate on affirmative action and deliberately misled the American public. Media coverage at the national level presented the controversy as a conflict primarily between African-Americans and whites, minimising the place of Latinos and Asian-Americans in the affirmative action debate.

In 1995, headlines, visuals, highlighted quotes and storyline emphasis demonstrated unavoidable conflict of interest between Whites and Blacks. The media portrayed African-Americans purportedly gaining at the direct expense of whites. The continued use of the buzzword "preferences", in conjunction with affirmative action, intensified the emotional context of the issue. The news reinforced racial antagonism, while perpetuating the idea

The so-called Serb massacre of some 45 Albanians in Racak, Kosovo, which made international headlines and was later used to justify the NATO bombings, is now classed as part of a US disinformation campaign.

that the White majority is fed up with affirmative action. This false perception may have discouraged White politicians who might otherwise have defended the policy. Since the media have made affirmative action an issue concerning only Blacks and Whites, Latinos and Asians have been left in peripheral positions and women and Native Americans barely register on the radar screen.

Sources: Robert Entman ([entmen@ncsu.edu](mailto:entmen@ncsu.edu)), "The Color Game: How Media Plays the Race Card", News Watch, Summer 1999; Linda Jue, "It is the Nuances, Stupid", News Watch, Summer 1999.

### 17. World Bank's Resettlement Programs Displace Millions of People

The World Bank funds large dam-building projects, but does little to help the displaced millions who are forced to relocate. A recent report by the World Bank's Operations Evaluation Department (OED) shows the Bank's failure to implement its own resettlement policy. The most recent data available indicates that 1.9 million people are being displaced by projects in the Bank's current portfolio, and that these numbers are continuing to grow.

One of the biggest concerns aroused by the authors of the OED report is the Bank's inability to restore the incomes of those resettled. The report recommends that the Bank move away from its policy of offering replacement land for land lost to a project. "In reality, resettlers lose the best land in the area—river valley land—and it's replaced with the most awful land around, because that is what is left."

Source: Lori Pottinger ([lori@irn.org](mailto:lori@irn.org)), "World Bank's Record on Resettlement Remains Troublesome", World Rivers Review, December 1998.

### 18. Minors in California are being Tried as Adults in the Criminal Justice System

It is unclear how many minors are getting bumped into the "big leagues" via fitness hearings which determine whether they should be tried as adults. Due to the lack of a tracking system, there is no way to determine where these minors are ending up, or if trying minors as adults is an effective deterrent or rehabilitation method. Research shows that 80 to 90 per cent of juveniles who did undergo fitness hearings ended up in adult court.

In 1994, two California State Assembly members "courting tough-on-crime votes revamped section 707 of the penal code, making it easier to try teens accused of serious offenses in the adult system".

Paul S. D. Berg, PhD, a forensic pathologist who has testified in three or four dozen fitness hearings, stated: "The only cases that end up in these hearings are serious cases, so the criterion is met by definition."

Source: A. Clay Thompson ([ac\\_thompson@sfbg.com](mailto:ac_thompson@sfbg.com)), "The Lost Boys: California is trying kids as adults—and locking them up for life. No one knows how many", The San Francisco Bay Guardian, 27 January 1999.

### 19. Cow's Milk Bacterium May Cause Crohn's Disease

Research points to a possible connection between gastrointestinal Crohn's disease and the milk we drink. Four studies show that the bacterium *Mycobacterium paratuberculosis*, which is found in the almost identical Johne's disease in cattle, survives the pasteurisation process and can infect us through the dairy products we consume. This disease has already infected between 500,000 and one million people in the US alone, and approximately 55 Americans are newly diagnosed each day. At least half of these victims will have an inflamed intestine surgically removed.

Both medical and veterinary researchers agree that there is cause for concern and great need for further investigations, yet neither the government nor the dairy industry is willing to touch the issue. Forty-five per cent of dairy producers are either unaware of the disease or know very little about it, despite the fact that the dairy industry is losing US\$1.5 billion a year from animals lethally infected with Johne's disease.

Source: Lisa Chamberlain ([lchamberlain@freetimes.com](mailto:lchamberlain@freetimes.com)), "The Crohn's Connection?", Cleveland Free Times, 16–22 June 1999.

### 20. IMF and World Bank Contributed to Economic Tensions in the Balkans

The International Monetary Fund (IMF) and the World Bank were leading contributors to economic tensions in the Balkans that stimulated the break-up of Yugoslavia. Declassified documents from 1984 reveal that a US National Security directive, entitled "United States Policy Towards Yugoslavia", set a policy for destabilising the Yugoslavian Government.

In the early 1980s, the World Bank and IMF provided loans to the former Yugoslavia supposedly to "fix" the economic hardship of the region. The loans from these two organisations included mandated macroeconomic restructuring that, rather than helping, in fact destroyed the industrial sector and dismantled the welfare state. In 1990, the IMF and the World Bank delivered a new "financial aid package" that required new and extensive expenditure cuts by the federal government. The IMF and World Bank involvement led to the impoverishment of the population, which in turn led to hatred, confusion and divisiveness.

Source: Michael Chossudovsky, "Banking on the Balkans", THIS, July/August 1999.

### 21. The Vatican's UN Status Challenged

A special delegation to the Vatican (the Holy See) holds a position in the United Nations that is more powerful than any other non-governmental organisation (NGO), enjoying the same status as politically neutral Switzerland.

The Holy See claims to be the representative of "the entire people of God", and promotes its agenda by threatening to "pull out" any of the 300,000 health care facilities it owns worldwide, if the UN should attempt to force any of those facilities to provide abortion or contraception services. This threat creates a hostage situation for poorer countries that are reliant on the Church for poverty relief and basic health care.

**The Holy See claims to be the representative of "the entire people of God", and promotes its agenda by threatening to "pull out" of any of the 300,000 health care facilities it owns worldwide, if the UN should attempt to force any of those facilities to provide abortion or contraception services.**

The See Change Campaign was launched to challenge the Vatican's power. Frances Kissling, president of Catholics for a Free Choice, asks: "Why should an entity that is in essence 100 square acres of office space and tourist attractions in the middle of Rome, with a citizenry that excludes women and children, have a place at the table where governments set policies? If the Vatican is a state," she says, "then EuroDisney deserves a place on the Security Council."

The Church's opposition prevented UN peacekeepers from distributing RU486 to rape victims in Kosovo.

Source: *Laura Flanders (Lflanders@aol.com), "Giving the Vatican the Boot", Ms. Magazine, October/November 1999.*

## 22. US and Germany Trained and Developed the Kosovo Liberation Army

Since the early 1990s, Germany and the USA have collaborated in supporting the development and training of the Kosovo Liberation Army (KLA) deliberately to destabilise a centralised socialist government in Yugoslavia. Undercover support of Kosovo's rebel army was established as a joint endeavour between the CIA and Germany's Bundesnachrichtendienst (BND).

Since the mid-1990s, there has been a handful of Pentagon contractors or private military companies providing support to the KLA. One of these contractors is Military Professional Resources, Inc. (MPRI), which employs more than 400 personnel and can access the résumés of thousands of former US military specialists.

There has also been a blurring of law enforcement and military activities by companies like Dyncorp and Science Application International Corporation (SAIC). One of Dyncorp's UN police monitors was wounded by pro-Indonesian East Timorese militiamen in the post-referendum violence that swept the territory. Others, providing police services in NATO-occupied Kosovo, were attacked by both Serbian and Albanian militia groups.

Source: *Wayne Madsen (wmadsen777@aol.com), "Mercenaries in Kosovo: The US Connection to the KLA", The Progressive, August 1999.*

## 23. International Conference Sets World Agenda for Peace

The Hague Appeal for Peace (HAP) Conference, which took place in The Netherlands in May 1999, set a "Global Agenda" for world peace in the 21st century. Ten thousand peace activists, Nobel Peace Prize winners and celebrities from a hundred different countries met for four days in to voice their suggestions on how to make international peace possible.

One campaign launched at the conference was the International Action Network on Small Arms (IANSA), which will encourage tracking, protesting and publicising the sales and shipments of weapons. Referring to the fact that the United States sold \$119 billion in arms (some 45 per cent of the world's total) from 1989 to 1996, Pierre Sane of Amnesty International stated at the conference that the US is "becoming the arsenal of the world".

The Hague Global Agenda calls for recognition and enforcement of World Court rulings that over 150 countries have endorsed. The United States has been unwilling to submit to the international jurisdiction of the World Court.

A long-term project put in motion at the conference is Global Action to Prevent War. Its purpose is to establish a coalition of organisations that will build a permanent body of NGOs, individuals and, eventually, governments to support world peace.

Source: *Robin Lloyd (tfmag@aol.com), "United for Peace", Toward Freedom, July 1999.*

## 24. US Nuclear Weapons Controlled by Mentally Unstable Personnel

Mentally unstable individuals may be in control of US nuclear devices. A screening process called the Personnel Reliability Program (PRP), set in place after a near-disaster in 1959, is supposed to guarantee that only competent, stable and dependable individuals have access to America's nuclear arsenal.

PRP is a two-step process consisting of an initial screening and post-approval monitoring. Screening includes a cursory medical evaluation, review of the candidate's personnel file and a background check of professional, educational and personal histories. However, no routine psychological testing is done, and an expelled PRP Marine has claimed that heavy drinking and depression are overlooked. In certain cases, individuals still had their PRP clearance while in prison on a felony conviction. In several cases, PRP-certified people have gone on to commit suicide or murder, assault, rape and other serious crimes, exposing unstable mental conditions in their past and present.

Source: *Ken Silverstein (ksilverstein@erols.com), "Positive Attitude Toward Nuclear Weapons Duty", Mother Jones, November 1998.*

## 25. US Military Trains Soldiers to Hunt, Kill and Eat Tame Animals

People for the Ethical Treatment of Animals (PETA) estimates that more than 10,000 animals, including chickens,

rabbits and goats, are used each year at military installations around the country in military training classes.

"Survival Skills" teaches soldiers to hunt, kill, cook and eat the tame animals.

Transported to training grounds by truck, the soldiers stage an ambush of an animal-laden vehicle, and release, chase, capture and kill the animals. They are "required to stroke the rabbit to calm it, then bash it on the head—and the rabbits don't always die with the first blow".

Two Air Force bases alone used more than 1,500 rabbits each year at a cost of more than \$10,000, and, according to a 1997 Department of Defense report, the Air Force kills more rabbits in survival skills courses than does the DoD in all its intramural research facilities combined.

Source: *D'Arcy Kemnitz (darcy@wildlifeAdvocacy.org), "Irrational Rations: Animals Used in Military Training", The Animals' Agenda, July/August 1999.*

**Mentally unstable individuals may be in control of US nuclear devices.**

**In several cases, personnel have gone on to commit suicide or murder, assault, rape and other serious crimes, exposing unstable mental conditions in their past and present.**





# THE INTERNATIONAL DRUG COMPLEX

*Criminal forces in collusion with established elites have put the drug industry on a truly transnational footing, while increasing their power over individuals, societies and economies.*

**Part 2 of 2**

by Hans T. van der Veen © 1999

European University Institute  
San Domenico, Italy

Published on the Internet by  
Centre for Drug Research (CEDRO)  
University of Amsterdam, The Netherlands  
E-mail: CEDRO@frw.uva.nl  
Website: www.frw.uva.nl/cedro/

## THE POLITICAL ECONOMY OF DRUG LAW ENFORCEMENT

The growth of the drug industry and concomitant real or perceived threats to states' authority gave an important impulse to the development of law and the organisation of crime control. Since the beginning of the 20th century, starting with the Shanghai Conference in 1909, step by step a global prohibition regime was created, sanctioning the production, dealing and trafficking of psychotropic substances.<sup>8</sup> Almost every country in the world, by ratifying international treaties, obliged itself to adapt its national laws in accordance with these treaties and thereby to suppress the now illegal drug business.

The responsibility for control and furthering the design of the regime came to fall on the United Nations in 1946.<sup>9</sup> This regime is still under construction, targeting new drugs and expanding its organisational structure. It encompasses multinational organisations, state bureaucracies, banks, medical institutions and morality. Thereby an unprecedented regulatory framework is established, comparable to the non-proliferation regime for nuclear weaponry. In the evolution of this international regime, individual states attained a high degree of worldwide uniformity and mutual tuning in the regulation of one category of intoxicating, mind-bending substances (Gerritsen, 1993:75).

There exists a formal global prohibition regime, but, to date, there is no global criminal justice system to meet the challenge of drug trafficking and globalised crime. Although formal regime control and design are with the United Nations, execution and dedication of control efforts are in the hand of governments and state agencies of individual nation-states. In spite of formal compliance to the predispositions of the prohibition regime, in practice the strategies and tactics for its enforcement are broadly disputed.

Historically, the conception of the 'drug problem' has been subject to dramatic transformations. Fiscal, balance of payments, civic security, public health, social welfare and moral considerations can be found as determining the main diagnosis of the problem. Within and between societies, the conception of the problem and the discourses guiding government intervention in the drug industry vary widely, over time and in geographic space. The multi-dimensionality of the drug problem makes it a very complex policy field. With prohibition in place, repression is still no panacea.

It was only after their dependencies gained independence that the major European powers dissolved their colonial monopolies on the opium trade. Prohibition also met with fierce resistance from the pharmaceutical industries in Germany, Japan and Switzerland. These were often shielded by state interests in the preparation for war, in which the secured supply of anaesthetics plays an important role. Coaxing governments into compliance with prohibition has been, and still is, an arduous process.

From the beginning, it has been the United States that has taken the lead in building the prohibition regime. Especially since the 1980s, unilateral, bilateral and multilateral forms of pressure, intervention and collaboration have been proliferating to force governments to comply with prohibition and to stifle the growth of the drug economy. Conditional development aid, extradition treaties (so-called International Mutual Legal Assistance Treaties), new types of financial policing to 'chase the money' around the international banking system, financing and advising foreign military and police, political pressure and even outright military intervention count among the plethora of instruments applied in the relations between states in this War on Drugs. In the process, institutional structures (e.g., Interpol, Europol, UNDCP) are strengthened to intensify international cooperation.

Besides that, many informal structures have developed between police, military and

intelligence agencies (see Anderson *et al.*, 1995; Anderson and den Boer, 1994; Benyon *et al.*, 1994, Fijnout, 1993; Marshall, 1991). Many of these are not new. Before the end of the Cold War, countries like France and the United States had extensive programs for the assistance of foreign military and police forces (Fijnout, 1993; Marshall, 1991). Nowadays, however, such programs are legitimised by the supposed need to strengthen other states' capabilities to fight the drug industry. Since the mid-1980s, through the process of European integration, the European Union also has been asserting itself as a major player in the field.

The internationalising powers to enforce the prohibition regime are largely legitimised and rationalised by interdependencies that derive from the global division of labour in the illegal drug industry and the concomitant problems this presents to individual states to control the drug industry. But forthcoming interdependency does not necessarily mean greater integration (collaboration and harmonisation). Interdependency can possibly also mean "dependency", "exploitation", "free riding" and "conflict" (Bühl, 1995:123).

International law-enforcement instruments are unevenly distributed and include the exchange of information between law enforcers, international pressures on countries to shape their legislative body (for example, with the closure of coffee shops and the lifting of bank secrecy), the provision of military aid and advisers (an important element of the American efforts in Latin America), or the extension of 'intelligence'-gathering by liaison officers stationed in foreign countries. The control over these instruments ultimately touches on the control that countries have over their economies and political system, and on the control people have over their privacy and sovereignty.

#### POWER & SOCIAL CONTROL

The strategies and tactics applied by governments in their drug policies not only touch upon very different conceptions of 'the drug problem', but they also affect the distribution of income within and between societies and the level of protection that citizens can attain.

Interventions in drug markets influence the direction, composition and volume of drug streams around the world and of the flows of money that are generated in this international business. They thereby touch upon the distribution of wealth that can be accumulated in the drug business and the relative power of players within and between societies.

Drug interests are strong enough to create powers that can play a major role in political life and economic activities. Where many people depend on the drug industry for their income, and where the overall economy is dependent on the influx of foreign currencies from the drug trade, such drug interests—and concrete efforts of drug entrepreneurs to protect their trade—severely limit the margins for governments to deal with the drug industry. Moreover, enhanced drug repression also strengthens coercive and other powers within state apparatuses relative to each other and the society at large.

Drug policies therefore also have an impact on the distribution of power and security in and between countries. On the one hand, they can limit the destabilising effect of the drug industry on society. On the other hand, enhancing the resources and legal powers

of a state's security forces can also limit the sovereignty of individuals, peoples and countries, and hence the level of freedom, democracy and human rights they can enjoy.

Drug repression thus also attains an important political dimension. From the perspective of the ruling elites, it is of concern to prevent power-contending ethnic, political or clan associations from using the drug proceeds for building their own power structures. In such a situation, they may have little choice but to gain control over the business themselves, or at least find a way of incorporating such new, dynamic sectors into the existing power structure. In many cases, drug repression would only strengthen the opposition as it would leave a good share of the population without means of support.

Domestic and foreign drug policies thus touch upon the distribution of power, wealth and security, both within a country and between societies. These interests are informing, if not imposing, a specific logic on many a state's policies and practices, and they lead to systemic interactions between the upperworld and the underworld, that play a decisive role in deepening their perverse impact on the relations among states and between states and their societies. The phenomenon of "protected trafficking" here enters the picture (Scott and Marshall, 1991:vii), where the selective suppression and protection of the drug industry becomes a more likely outcome of drug policies.

**Drug interests are strong enough to create powers that can play a major role in political life and economic activities.**

#### LINKS BETWEEN ORGANISED CRIME & THE POWER ELITE

Criminal groups (and criminally obtained resources) are often a deviant element in the national and international dynamics of politics. The illegitimate use of violence and 'authorised' force to serve the purpose of one class, clan, ethnic group, region or country against the other is no new phenomenon. However, it is strongly related to the dynamics and consequences of the growth of drug markets and the state policies implemented to control them. In many countries, it is exactly the association of criminal groups

with power elites that produces and prolongs such perverse consequences (Hess, 1986:128).

In the recent history of both industrialised countries (e.g., France, the United States and Italy) and developing countries (e.g., Turkey, South Africa, Colombia, Mexico), many examples can be found of cooperation between secret services, political parties and other elite power groups with drug-trafficking criminal groups in the repression of domestic opposition, the destabilisation of foreign governments and the support against (geo)political foes (see, for example, Block and Hess, 1986; Krüger, 1980; McCoy, 1972; Scott and Marshall, 1991). Equally, many opposition groups have discovered how important drug income can be to withstand (foreign) control over their territories (e.g., the PKK in Turkey, the Shining Path in Peru, and the Afghan Mujahedin).

Such symbiotic relations between drug entrepreneurs and local, national or foreign power elites are often amended by forms of corruption of a more or less institutional nature. The price-increase effect of prohibition works effectively as a tax which does not flow straight into the coffers of the state treasury, however, but is collected by the producers, traffickers and other service providers in the trade. In many countries, though, a prohibition tax is equally levied by 'corrupt' enforcement officers and other protectors of the trade within the politico-administrative system.

However, such state-induced extortion or bribing of the trade is not only an activity for private gain (supplementing salaries). In fact, various systems exist that provide for the distribution of such rents within hierarchical networks through which such money flows. In return, they facilitate exchange in prohibited markets.

Bribery can be a primary method of public finance, alongside taxation, borrowing and inflation (Thornton, 1991:137). From that perspective, it should be less of a surprise to find police officials actively involved in the management and maintenance of the black-market monopolies. Through their relations with drug entrepreneurs, police officers and other state protectors become responsive to the monopolist. This may lead them to act against new entrants or third parties in the pursuit of maintaining the monopoly and its profits.

Such symbiotic relations are often an outcome of law enforcement tactics, where drug enforcement agencies infiltrate trafficking rings and set up 'front' stores to provide services to the drug industry.

The War on Drugs in many countries is literally running out of control. A severe crisis upset the Dutch police and juridical system when it turned out that the methods used by police agencies in their criminal investigations of drug traffickers had to a large extent devolved beyond juridical boundaries and parliamentary control. The Dutch parliamentary commission which investigated these methods in 1996 found, for example, that 285 tonnes of drugs had been imported by the Dutch police, of which 100 tonnes had disappeared onto the market (Zwaap, 1996).<sup>10</sup>

The opportunities for bribery and outright extortion, facilitated by the outlaw position of drug entrepreneurs, constitute an important incentive for the escalation of the drug war. In a more formalised way, asset seizure laws have had the same result (Benson, Rasmussen, Solars, 1995; Benson and Rasmussen, 1996). In fact, the idea of self-financing police forces is now also actively propagated by Pino Arlacchi, director of the United Nations Office for Drug Control and Crime Prevention (AFP, 31 March 1999).

#### **ECONOMIC, SOCIAL & POLITICAL IMPLICATIONS**

To a greater or lesser extent, the narcotics industry has become economically and socially entrenched in almost every country in the world. Drug-related interests have permeated many sectors of society—sectors which often function in the formal economy but derive part of their income from activities connected to the drug trade. Few sectors remain untouched by the drug industry, as drug proceeds are consumed and invested in other enterprises or as banks and transport companies, for example, provide services to the drug industry and so become part of the drug industry themselves.

The drug industry is to varying degrees also socially embedded in many countries. Certainly, drug consumption is culturally rooted in not only the most marginalised sectors of the population. Furthermore, drug entrepreneurs increasingly establish themselves as a social force that seeks integration in the formal institutions of the societies in which they live and operate. Thereby, they often gain if not the respectability, then at least some leverage to protect

their interests. The income and employment the industry generates, for a multiplicity of players and societies at large, also do not fail to provide political clout to drug-related interests, especially when threatened by foreign or domestic repression efforts. However, prohibition severely hampers the formal incorporation of the drug industry through taxation, interest mediation and forms of market, labour and product regulation.

It is my contention that from the consequential partial, informal or denied integration derive many of the most harmful consequences of the industry's operations, much more so since police and military institutions are ill-equipped to perform these regulatory roles.<sup>11</sup>

As both the drug industry and drug law enforcement are internationalising, they put severe strains on the possibilities of the state to incorporate the drug industry in local and domestic arrangements which could limit their destabilising effects on society. However, such a strategy, if applied—and many countries cannot escape such a choice, either by informal arrangements or through 'corruption'—becomes less feasible where the power of organised crime and pressures for intensified law enforcement upset such symbiotic relations.

The drug industry and drug repression, certainly where they cross the borders of other states, can therefore have very disruptive effects on domestic political-economic institutions and arrangements. This can come about merely as an unintended consequence of conscientious cross-border supply reduction efforts. However, in many instances, drug policies are merely part of other foreign policy goals and are to a large extent shaped by the institutional logic of agencies called in to implement them.

Recent history has shown that, rightly, much more calculation tends to play a role in supply-side policies than in zealous supply reduction. Such policies also take into account the interests involved in drug trafficking, and the capabilities of governments to offset the

pressure put on these interests by efforts to stifle the drug economy (for example, crop substitution projects carried out by the United Nations with the aim of providing drug farmers with an alternative source of income, or the provision of arms to the Colombian military). However, as soon as drug policies become part of broader policy goals towards other countries, they are likely to be subordinated to other priorities that states pursue to protect their national interests.

Just as war is the continuation of politics by other means, so the War on Drugs has become an extension of foreign policy by other means (Marshall, 1991:ii). International drug policies almost inescapably become enmeshed with geopolitical and economic considerations (LaBrousse and Koutouzis, 1996). So, enhancing the powers of specific law-enforcers—such as, in an extreme case, the military in Peru or Colombia—is also likely to serve interests quite different from convincing coca growers to limit their output. In the most brutal form, international drug law enforcement can legitimise outright military intervention, as the Panamanians experienced in the late 1980s.

**To a greater or lesser extent, the narcotics industry has become economically and socially entrenched in almost every country in the world.**

**Few sectors remain untouched by the drug industry, as drug proceeds are consumed and invested in other enterprises or as banks and transport companies.**

In the foregoing paragraphs I have built an analytical framework for studying the underlying dynamics, outcomes and consequences of the War on Drugs. Thereby, I've tried to show how the growth of global networks of crime and the internationalisation of law enforcement are shaped by some fundamental changes in the global political and economic system. I've also focused on how the War on Drugs is likely to be subverted by interests of both drug entrepreneurs and the powers that are called in to control the drug industry. Through their symbiotic and systemic interactions, they are the most likely beneficiaries of this war.

As their interactions take place in a competitive world with unevenly distributed resources, the outcomes of their interactions are also likely to impinge unevenly on different societies and groups within them. The criminal system permeates the political and economic system, undermining the functioning of legal industries and the role and functioning of the state. The extension of states' coercive powers to 'control' the drug industry also impinges heavily on the distribution of power, wealth and security within and between societies, often through practices that escape democratic control.

The destructive force of the intertwined dynamics of the drug industry and state repression is thereby likely to demolish the existing relations between states, markets and societies. Therewith, the underlying dynamics and outcomes of the drug war are not only shaped by but are also reshaping the fundamental structures of the world's political economy.

### THE INTERNATIONAL DRUG COMPLEX

In this section I argue that interests in the drug industry and in drug law enforcement collide in both domestic and international domains to form the International Drug Complex.

In analogy with the theory of the Military Industrial Complex—developed since the 1960s to explain the longevity of the Cold War, the arms race, the persistence of anti-communist ideology and political interventions in people's lives and societies—I have tried in this paper to assemble and understand the mechanisms

and dynamics that might explain the flourishing of both drug economies and new regulatory frameworks for 'state' control.

Therewith, I hope to elaborate a theory of the International Drug Complex. This theory tries to explain both the prolongation of the War on Drugs and the flourishing of the drug economy, by focusing on political and economic interests that shape relations between drug markets and state interventions in these markets.

The basic hypotheses I try to further are that the dynamics within and between the social forces at both sides of the law do not tend to keep each other in check, but, rather, reinforce each other, either by acting in concert or through more systemic interactions.

Through this, a 'community of interest'—a coalition of groups with vested psychological, moral and material interests—develops between drug entrepreneurs and coercive state agencies or the power elites that control them. This mutual support takes many shapes and has many levels, changing over time and location. However, the consequence of this collusion is that the interests of both groups are advanced to the detriment of third parties and areas of the societies in which they flourish. The drug industry and drug law enforcement, in this approach, are not necessarily opposite to

each other but develop a more or less intertwined and interdependent dynamic—a sort of countervailing but also mutually reinforcing 'coalition' that serves the interests of both, independent of democratic control by citizens and sometimes even governments.

Globalisation, neoliberal reforms and the end of the Cold War have strongly affected the regulation of relations among states and the relation between states and societies. The Cold War system imposed relative stability in the international state system, as well as order and discipline within both camps and a more general foundation for stability in the world economy. The Cold War did not lead to a major conflict between the superpowers, and it diminished the possibilities for war between states; but it also charged a heavy toll on peoples squeezed between the antagonistic claims to maintain political and ideological unity within the superpowers' self-proclaimed spheres of influence.

**The criminal system permeates the political and economic system, undermining the functioning of legal industries and the role and functioning of the state.**

### Bibliography

- Akida, Okon, "International Trade in Narcotic Drugs: Implications for Global Security", *Futures* 29(7):605-16, 1995.
- Albin, Joseph, "The Distribution of Drugs: Models of Criminal Organization and Their Integration", in Thomas Mieczkowski (ed.), *Drugs, Crime, and Social Policy*, University of South Florida, Simon & Schuster, 1992, pp. 79-108.
- Anderson, Malcolm and Monica den Boer (eds), *Policing Across National Boundaries*, Pinter Publishers, London, 1994.
- Anderson, Malcolm et al., "Policing the European Union: Theory, Law and Practice", *Clarendon Studies in Criminology*, Clarendon Press, Oxford, 1995.
- Andreas, Peter, "Free Market Reform and Drug Market Prohibition: US Policies at Cross-Purposes in Latin America", *Third World Quarterly* 16(1):75-87, 1995.
- Bagley, Bruce, "Myths of Militarisation: Enlisting Armed Forces in the War on Drugs", in Peter H. Smith (ed.), *Drug Policy in the Americas*, 1992, pp. 129-50.
- Belenko, Steven, *Behind Bars: Substance Abuse and America's Prison Population*, The National Center on Addiction and Substance Abuse, Columbia University, 1998.
- Benyon, John et al., "Understanding Police Cooperation in Europe: Setting a Framework for Analysis", in Anderson and den Boer (eds), *ibid.*
- Block, Alan A., "A Modern Marriage of Convenience: A Collaboration Between Organized Crime and US Intelligence", in Robert J. Kelly (ed.), *Organized Crime: A Global Perspective*, 1986, pp. 58-78.
- Bühl, Walter, "Internationale Regime und Europäische Integration", *ZfP* 2(2), 1995.
- Centre Tricontinental, "Drogues et narcotraffic: le point de vue du Sud", *Alternatives Sud, Cahiers Trimestriels* 3(1), 1996.
- Cerny, Philip G., "Globalization and the Changing Logic of Collective Action", *International Organization* 49(4):595-625, 1995.
- Chatterjee, S.K., *Legal Aspects of International Drug Control*, 1981.
- Dorn, Nicholas, Jorgen Jepsen and Ernesto Savona (eds), *European Drug Policies and Enforcement*, Macmillan Press Ltd, 1996.
- Drug war facts: <http://www.csdp.org/factbook/military.htm>.
- Economische en Statistische Berichten (ESB), 26 June 1996.
- Estievenart, Georges (ed.), *Policies and Strategies to Combat Drugs in Europe: The Treaty of the European Union: Framework for a New European Strategy to Combat Drugs?*, Martinus Nijhoff Publishers, Dordrecht, 1995.
- Fijnout, Cyrille (ed.), *The Internationalisation of Police Cooperation in Western Europe*, Kluwer, Deventer, 1993.
- Foust, Dean and Gail DeGeorge, "The New, Improved Money Launderers", *Business Week*, 28 June 1993.
- Gereffi, Gary and Miguel Korzeniewicz (eds), *Commodity Chains and Global*

With globalisation and the end of the Cold War system, states' legitimation and capacities to maintain internal order and protection against external threats have quickly diminished. Neoliberal reforms and regional integration have only accelerated the incapacity of individual states to manage the interface between their society and the rest of the world and to intervene in the distribution of opportunities within society.

In the protection of the state, internal and external security are closely related. For half a century, military-industrial elites have nearly always prevailed over domestic rivals without much difficulty. Fear of the foreign foe has persuaded political managers and the population at large to acquiesce in new efforts to match and overtake the other side's armaments. The escalating arms race, in turn, has helped to maintain conformity and obedience at home, since an evident outside threat is, as always, the most powerful social cement to humankind (McNeil, 1982:382).

The vast, armed establishments that protected the NATO and Warsaw Pact powers against one another, their ideological strife and the legitimation for domestic control and foreign interventions are nowadays being supplanted by an extension of the strong arm of the law in private, domestic and foreign domains.

Today, a qualitative and quantitative shift has been brought about in the constitution and dedication of the coercive apparatuses of states. In public discourse, in government budgets and in the daily lives of many of us, we are witnessing important transformations—transformations in the dominance of acclaimed threats (from communism to drugs, crime and foreigners), in the priority given to financing for the preservation of internal order instead of external security arrangements (from the military to policing institutions), and in states' demands on citizens to acquiesce to restrictions on spending power, consumer freedom, personal privacy, sovereignty and liberty in order to comply with international demands to 'harmonise' efforts in countering the scourge of drug trafficking and other forms of criminalised activities.

The discourse and state activities supporting these

transformations are to a large extent based on new foes—basically, the drug industry and its alleged connections with organised crime, terrorism and migration. The 'red scare' is now substituted by the fear of drugs and organised crime. The fight against this 'white scare', however, poses for societies and states many of the same opportunities, dilemmas and systemic contradictions as they were facing during the Cold War.

Different from the Cold War era, which was dominated by external security concerns, coercive powers are nowadays basically set up for safeguarding internal security. However, such divisions are progressively blurred by the internationalisation of non-military threats to internal security. As a result, the traditional

divisions of labour between the police, military, secret service and other coercive state powers tend to lose their significance. Such developments can be seen in the militarisation of the War on Drugs, in the policing of external frontiers and in cooperative or interventionist activities of law enforcement agencies across borders.

So, in many respects, the War on Drugs is taking over the functions of the Cold War in legitimising the coercive use of state powers to foster internal order and discipline, but also

in setting up control mechanisms to defend the state and society against external threats at home and abroad. However, the internationalisation of police cooperation and the concomitant proliferation of tools to intervene in the sovereignty of individuals, peoples and foreign countries are highly liable to decrease the prospect of a world order in which peace, justice and freedom can develop. This is mainly due to the uneven distribution of the powers unleashed by the International Drug Complex.

On the one hand, the globalising forces of crime, monetary volatility and migration, for instance, decrease the possibilities of protecting the state and the social arrangements that support it. The increasing overlap this brings about between internal and external security concerns is likely to lead to the formal goals of the drug war being overruled by geopolitical and economic

**The War on Drugs is taking over the functions of the Cold War in legitimising the coercive use of state powers to foster internal order and discipline ...**

*Capitalism*, Greenwood Press, Westport, Connecticut, 1994.

- Gerritsen, Jan-Willem, *De politieke economie van de roes*, Proefschrift, Amsterdam, 1993.
- Hess, Henner, "The Traditional Sicilian Mafia: Organized Crime and Repressive Crime", in Robert J. Kelly (ed.), *Organized Crime: A Global Perspective*, 1986, *ibid.*, pp. 113-34.
- Jamieson, Alison, "Drug Trafficking After 1992: A Special Report", *Conflict Studies*, no. 250, Research Institute for Study of Conflict and Terrorism, 1993.
- Johnston, Les, *The Rebirth of Private Policing*, Routledge, London, New York, 1992.
- Kelly, Robert J. (ed.), *Organized Crime: A Global Perspective*, Rowman and Littlefield, 1986.
- Krüger, Henrik, *The Great Heroin Coup: Drugs, Intelligence, and International Fascism*, South End Press, Boston, 1980.

- LaBrousse, Alain and Michel Koutouzis, "Géopolitique et géostratégies des drogues", *Economica*, 1996.
- Marshall, Jonathan, *Drug Wars: Corruption, Counterinsurgency and Covert Operations in the Third World*, Cohen and Cohen, Berkeley, 1991.
- Mauer, Marc, *Americans Behind Bars: US and International Use of Incarceration*, 1995, The Sentencing Project, 1997.
- McCoy, Alfred W., *The Politics of Heroin in Southeast Asia*, Harper and Row, New York, 1972.
- McNeil, William H., *The Pursuit of Power*, University of Chicago Press, 1982.
- Miron Jeffrey A. and Jeffrey Zwiebel, "The Economic Case Against Drug Prohibition", *Journal of Economic Perspectives* 9(4):175-192, 1995.
- Naylor, R.T., *Hot Money and the Politics of Debt*, The Linden Press/Simon & Schuster, New York, 1987.
- Naylor, R.T., "From Cold War to Crime

- War: The Search for a New 'National Security' Threat", *Transnational Organized Crime* 1(4):37-56, 1995.
- NRC, Handelsblad, 10 March 1997.
- Observatoire Géopolitique des Drogues (OGD), *Géopolitique des drogues*, Editions la Découverte, Paris, 1995.
- Ouazzani, Ansaf, "Le kif au Maroc: de la survie au narco-trafic, le double versant du rif", in Centre Tricontinental, *Drogues et narco-trafic: le point de vue du Sud*, 1996, *ibid.*
- Perl, Raphael F. (ed.), *Drugs and Foreign Policy: A Critical Review*, Westview Press, Boulder, Colorado, 1994.
- Rosen, Steven (ed.), *Testing the Theory of the Military-Industrial Complex*, Lexington Books, Lexington, Massachusetts, 1973.
- Rosenau, James N., "The Relocation of Authority in a Shrinking World", *Comparative Politics*, April 1992.
- Scheptycki, J.W.E., "Law Enforcement, Justice and Democracy in the Transnational

concerns. The coercive powers of states, which are called in to maintain internal order and external security, tend to a large extent to escape democratic control, as their 'operational information' activity needs to be shielded from the outside world. Diminishing accountability goes hand in hand with the increased powers assigned to coercive state agencies.

However, more than this threat of free-floating state power, it is the subversive impact of international criminal organisations that undermines the very basis of the states and the societies they preside over. If indeed law enforcement directed against the drug industry is also counterproductive—and thus serves quite different political goals—this leaves us with a less than gloomy perspective for the future development and democratisation of our societies.

### TRANSNATIONAL DIMENSIONS

Since the end of the Cold War, the so-called New World Order—established under conditions of increased globalisation and underwritten by neoliberal reforms—is largely shaped by two forces: the visible hand of criminal forms of market control, and the extension of the strong arm of the law in the national and international domain.

These two forces of repression and subversion increasingly show the tendency to squeeze the populations of entire societies into a spiralling anarchy, endangering the constitutional state and the living conditions of its citizens.

Both sides of the law, although formally opposed to each other, in fact enhance each other's growth and therewith their impact on the rest of society. In their mutual (systemic) interactions, they permeate societies with a logic reminiscent of the way in which, during the Cold War, the two antagonistic superpowers and their military-industrial complexes on the one hand fostered the control over their spheres of influence, and on the other hand incapacitated their populations to counter the pressures of vested interests in a spiralling arms race that enhanced the income, prestige and power of military establishments and the profits of

weapons industries that fed the threat of war.

The two worlds of criminal entrepreneurs and coercive agencies of states are not separated by geographical boundaries, however; nor are they separated from the societies in which they function. As both increasingly attain transnational dimensions, they become more disposed to prevent themselves from being incorporated into society and, hence, from being subordinate to democratic control. At the same time, they increase their powers to penetrate the sovereignty of individuals and entire societies over the globe.

### Endnotes

8. The substances covered by this regime are expanding with technological developments in pharmacology, while new 'designer' drugs are rapidly proliferating and being incorporated in the prohibition regime. The principal targets for control are opiates, followed by coca and cannabis derivatives. Other substances with prohibited marking are denominated by their active substances.

9. For an overview and analysis of the development of this global prohibition regime, see for instance Stein (1985), Gerritsen (1993) and Silvis (1993).

10. In June 1999, a new Dutch parliamentary commission (Kalsbeek-commission) concluded that double-informants, with the help of drug officers, had managed to import and market an additional 15,000 kilograms of cocaine (NRC, 10 June 1999).

11. As in many other black-market sectors such as illegal gambling and prostitution, exchanges in the drug industry are of a consensual nature. The criminalisation of personal vice, as opposed to some of the consequential social harm it inflicts on society, thus leads to what some authors call 'victimless crime'. Both this consensual nature and the fact that prohibition pushes all exchanges underground, have far-reaching implications for the tactics of law enforcement agencies in the process of evidence-gathering, as participants are unlikely to issue complaints or invoke arbitrage from formal institutions, even when disputes arise. Moreover, many of the negative consequences associated with illegal drugs derive from the prohibition rather than the consumption of the prohibited goods (Miron and Zwiebel, 1995).

**Both sides of the law, although formally opposed to each other, in fact enhance each other's growth and therewith their impact on the rest of society.**

### Bibliography (continued)

- Arena: Reflections on the War on Drugs", *International Journal of the Sociology of Law* 24, 1996.
- Scott, Peter Dale and Jonathan Marshall, *Cocaine Politics: Drugs, Armies and the CIA in Central America*, University of California Press, Berkeley, 1991.
  - Silvis, Jos, "Geschiedenis van de Internationale Strijd tegen Drugs" *Recht en Kritiek* 19(2), 1993.
  - Smith, Peter H. (ed.), *Drug Policies in the Americas*, Westview Press, Boulder, Colorado, 1992.
  - Stein, S.D., *International Diplomacy, State Administrators and Narcotics Control*, Gower Publishing Company Ltd, Aldershot, 1985.
  - Strange, Susan, *The Retreat of the State: The Diffusion of Power in the World Economy*, Cambridge University Press, 1996.
  - Thornton, Mark, *The Economics of Prohibition*, University of Utah Press, 1991.
  - Tullis, Lamond, "Beneficiaries of the Illicit

- Drug Trade: Political Consequences and International Policy at the Intersection of Supply and Demand", United Nations Research Institute for Social Development (UNRISD), Discussion Paper No. 19, March 1991.
- Tullis, Lamond, "Unintended Consequences: Illegal Drugs and Drug Policies in Nine Countries", *Studies on the Impact of the Illegal Drug Trade, Vol. IV*, Lynne Rienner Publishers, Boulder, Colorado, 1995.
- UNDCP (United Nations Drug Control Program), *World Drug Report*, 1997.
- Van der Vaeren, Charles, "The European Community's International Drug Control Cooperation Policy: A Personal View", in Georges Estievenart (ed.), 1995, *ibid.*, pp. 346-352.
- Wilson, Suzanne and Marta Zambranao, "Cocaine, Commodity Chains, and Drug Politics: A Transnational Approach", in Gary Gereffi and Miguel Korzeniewicz (eds),

*Commodity Chains and Global Capitalism*, 1994, *ibid.*, pp. 297-315.

- Youngers, Coletta, "La guerra en los Andes: El rol militar en la política internacional de los Estados Unidos sobre la droga", Series breves de la oficina sobre Latinoamérica en Washington (WOLA)/ CEDIB, December 1990.
- Zwaap, René, "Hassans gecontroleerde doorvoer", *De Groene Amsterdammer*, 14 February 1996.

### Editor's Note:

• Hans T. van der Veen's article is reprinted with permission from CEDRO, the Centre for Drug Research (Centrum voor Drugsonderzoek) at the University of Amsterdam, Nieuwe Prinsengracht 130, 1018 VZ Amsterdam, The Netherlands, telephone +31 (20) 525 4061 /4280 /7432, fax +31 (20) 525 4317, e-mail CEDRO@frw.uva.nl, website www.frw.uva.nl/cedro/.





# ***EXCITOTOXINS***

## **— DANGEROUS FOOD ADDITIVES —**

***Almost all processed foods contain powerful excitotoxins, such as MSG and aspartame, which are implicated in causing a variety of neurological disorders.***

***Part 1 of 2***

**by Russell L. Blaylock, MD © 1999**

First published in  
**MEDICAL SENTINEL**  
(vol. 4, no. 6, Nov-Dec 1999)  
PO Box 13648  
Macon, GA 31208-3648, USA  
Telephone: +1 (912) 757 9873  
Website: [www.haciendapub.com](http://www.haciendapub.com)

### **EXCITOTOXINS, NEURODEGENERATION AND NEURODEVELOPMENT**

**A** growing number of clinicians and basic scientists are convinced that a group of compounds called "excitotoxins" play a critical role in the development of several neurological disorders, including migraines, seizures, infections, abnormal neural development, certain endocrine disorders, neuropsychiatric disorders, learning disorders in children, AIDS dementia, episodic violence, lyme borreliosis, hepatic encephalopathy, specific types of obesity, and especially the neurodegenerative diseases such as amyotrophic lateral sclerosis (ALS), Parkinson's disease, Alzheimer's disease, Huntington's disease and olivopontocerebellar degeneration.<sup>1</sup>

An enormous amount of both clinical and experimental evidence has accumulated over the past decade, supporting this basic premise.<sup>2</sup> Yet, the FDA still refuses to recognise the immediate and long-term danger to the public caused by the practice of allowing various excitotoxins to be added to the food supply—excitotoxins such as MSG (monosodium glutamate), hydrolysed vegetable protein and aspartame. The amount of these neurotoxins added to our food has increased enormously since their introduction. For example, since 1948, the amount of MSG added to foods has doubled every decade. By 1972, 262,000 metric tons were being added to foods. Over 800 million pounds of aspartame have been consumed in various products since it was approved. Ironically, these food additives have nothing to do with preserving food or protecting its integrity; they are all used to alter the taste of food. MSG, hydrolysed vegetable protein and natural flavouring are used to enhance the taste of food, while aspartame is an artificial sweetener.

These toxins (excitotoxins) are not present in just a few foods, but, rather, in almost all processed foods. In many cases they are being added in disguised forms, such as natural flavouring, spices, yeast extract, textured protein, soy protein extract, etc. Experimentally, we know that when subtoxic levels of excitotoxins are given to animals in divided doses, the animals experience full toxicity, i.e., the excitotoxins are synergistic. Also, liquid forms of excitotoxins, as found in soups, gravies and diet soft drinks, are more toxic than that added to solid foods; this is because they are more rapidly absorbed and reach higher levels in the blood.

So, what are excitotoxins? These are substances, usually acidic amino acids, that react with specialised receptors in the brain in such a way as to lead to destruction of certain types of neurons. Glutamate is one of the more commonly known excitotoxins. MSG is the sodium salt of glutamate. This amino acid is a normal neurotransmitter in the brain. In fact, it is the neurotransmitter most commonly used by the brain. Defenders of MSG and aspartame usually ask how a substance that is used normally by the brain could cause harm. It is because glutamate, as a neurotransmitter, exists in the extracellular fluid only in very, very small concentrations—no more than 8 to 12  $\mu\text{M}$  [micromoles/litre]. When the concentration of this transmitter rises above this level, the neurons begin to fire abnormally. At higher concentrations, the cells undergo a specialised process of delayed cell death known as "excitotoxicity"; that is, they are excited to death.

It should also be appreciated that the effects of excitotoxin food additives generally are not dramatic. Some individuals may be especially sensitive and develop severe symptoms and even die suddenly from cardiac irritability, but in most instances the effects are subtle and develop over a long period of time. While the food additives MSG and aspartame are probably not direct causes of the neurodegenerative diseases such as Alzheimer's dementia, Parkinson's disease or ALS, they may well precipitate these disorders and certainly worsen their pathology—as we shall see. It may be that many people with a propensity

for developing one of these diseases would never develop a full-blown disorder if not for their exposure to high levels of food-borne excitotoxin additives. Some might only have had a very mild form of the disease, if not for the exposure. Likewise, food-borne excitotoxins may be harmful to those suffering from strokes, head injury and HIV infection, and certainly should not be used in a hospital setting.

### THE DISCOVERY OF EXCITOTOXINS

In 1957, two ophthalmology residents, Lucas and Newhouse, were conducting an experiment on mice to study a particular eye disorder.<sup>3</sup> During the course of this experiment, they fed newborn mice MSG and discovered that all demonstrated widespread destruction of the inner nerve layer of the retina. Similar destruction was also seen in adult mice, but was not as severe as in the newborns. The results of their experiment were published in the *Archives of Ophthalmology* and soon forgotten. For 10 years prior to this report, large amounts of MSG were being added not only to adult foods but also to baby foods, in doses equal to those given to the experimental animals.

Then, in 1969, Dr John Olney, a neuroscientist and neuropathologist working out of the Department of Psychiatry at Washington University in St Louis, repeated Lucas and Newhouse's experiment.<sup>4</sup> His lab assistant noticed that the newborn of MSG-exposed mice were grossly obese and short in stature. Further examination also demonstrated hypoplastic organs, including pituitary, thyroid and adrenal, as well as reproductive dysfunction. Physiologically, they demonstrated multiple endocrine deficiencies, including of TSH, growth hormone, LH, FSH and ACTH. When Dr Olney examined the animals' brains, he discovered discrete lesions of the arcuate nucleus as well as less severe destruction of other hypothalamic nuclei.

Since this early observation, monosodium glutamate and other excitatory substances have become standard tools in studying the function of the hypothalamus. Recent studies showed that glutamate is the most important neurotransmitter in the hypothalamus.<sup>5</sup>

Later studies indicated that the damage by monosodium glutamate was much more widespread, affecting the hippocampus, circumventricular organs, locus ceruleus, amygdala, limbic system, subthalamus and striatum.<sup>6</sup> More recent molecular studies disclosed the mechanism of this destruction in some detail.<sup>7</sup>

Early on, it was observed that when neurons *in vitro* were exposed to glutamate and then washed clean, the cells appeared perfectly normal for approximately an hour, at which time they rapidly underwent cell death. It was discovered that when calcium was removed from the medium, the cells continued to survive.

Subsequent studies have shown that glutamate and other excitatory amino acids attach to a specialised family of receptors (NMDA, kainate, AMPA and metabotropic) which in turn, either directly or indirectly, opens the calcium channel on the neuron cell membrane, allowing calcium to flood into the cell. If unchecked, this calcium will trigger a cascade of reactions, including free radical generation, eicosanoid production and lipid peroxidation, which will destroy the cell. With this calcium-triggered stimulation, the neuron becomes very excited, firing its impulses repetitively until the point of cell death, hence the name "excitotoxin". The activation of the calcium channel via the NMDA-type receptors also involves other membrane receptors such as the zinc, magnesium, phencyclidine and glycine receptors.

In many disorders connected to excitotoxicity, the source of the glutamate and aspartate is endogenous. We know that when brain cells are injured, they release large amounts of glutamate from surrounding astrocytes, and this glutamate can further damage surrounding normal neuronal cells. This appears to be the case in strokes, seizures and brain trauma. But, food-borne excitotoxins can add significantly to this accumulation of toxins.

**When excitotoxin taste-enhancers are added together, they become much more toxic than if taken individually.**

### COUNTERING THE FDA'S SPIN ON MSG SAFETY

In July 1995, the Federation of American Societies for Experimental Biology (FASEB) conducted a definitive study for the US Food and Drug Administration (FDA) on the question of safety of MSG.<sup>8</sup> The FDA wrote a very deceptive summary of the report in which it implied that, except possibly for asthma patients, MSG was found to be safe by the FASEB reviewers. But, in fact, that is not what the report said at all.

I summarised, in detail, my criticism of this widely reported FDA deception in the revised paperback edition of my book, *Excitotoxins: The Taste That Kills*, by analysing exactly what the report said and failed to say.<sup>9</sup> For example, it never said that MSG did not aggravate neurodegenerative diseases. What it said was, there were no studies indicating such a link; specifically, that no one has conducted any studies, positive or negative, to see if there is a link. A vital difference.

Unfortunately for the consumer, the corporate food processors not only continue to add MSG to our foods but go to great lengths to disguise these harmful additives. For example, they use such names as "hydrolysed vegetable protein", "vegetable protein", "textured protein", "hydrolysed plant protein", "soy protein extract", "caseinate",



"yeast extract" and "natural flavouring". We know experimentally that when these excitotoxin taste-enhancers are added together, they become much more toxic than is seen individually.<sup>10</sup> In fact, excitotoxins in subtoxic concentrations can be fully toxic to specialised brain cells when used in combination. Frequently on supermarket shelves I see processed foods, especially frozen or diet foods, that contain two, three or even four types of excitotoxins.

We also know, as stated, that excitotoxins in liquid forms are much more toxic than solid forms because they are rapidly absorbed and attain high concentration in the blood. This means that many of the commercial soups, sauces and gravies containing MSG are very dangerous to nervous system health, and should especially be avoided by those who have one of the above-mentioned disorders or who are at a high risk of developing one of them. They should also be avoided by cancer patients and those at high risk for cancer, because of the associated generation of free radicals and lipid peroxidation.<sup>11</sup>

In the case of amyotrophic lateral sclerosis (ALS), we know that consumption of red meats, and especially MSG itself, can significantly elevate blood glutamate to levels much higher than seen in the normal population.<sup>12</sup> Similar studies, as far as I am aware, have not been conducted in patients with Alzheimer's or Parkinson's disease. But, as a general rule, I would certainly suggest that persons with either of these diseases avoid MSG-containing foods as well as red meats, cheeses and puréed tomatoes, all of which are known to have higher levels of glutamate.

It must be remembered that it is the glutamate molecule that is toxic in monosodium glutamate. Glutamate is a naturally occurring amino acid found in varying concentrations in many foods. Defenders of MSG safety allude to this fact in their defence. But, it is free glutamate that is the culprit. Bound glutamate, found naturally in foods, is less dangerous because it is slowly broken down and absorbed by the gut so that it can be utilised by the tissues, especially muscle, before toxic concentrations can build up. Therefore, a whole tomato is safer than a puréed tomato. The only exception to this as stated, based on present knowledge, is in the case of ALS. Also, the tomato plant contains several powerful antioxidants known to block glutamate toxicity.<sup>13</sup>

Hydrolysed vegetable protein is a common food additive and may contain at least two excitotoxins: glutamate and cysteic acid. Hydrolysed vegetable protein is made by a chemical process that breaks down the vegetable's protein structure purposefully to free the glutamate as well as aspartate, another excitotoxin. This brown, powdery substance is used to enhance the flavour of foods, especially meat dishes, soups and sauces. Despite the fact that some health food manufacturers have attempted to sell the idea that this flavour enhancer is "all natural" and "safe" because it is made from vegetables, it is not. It is the same substance added to processed foods. Experimentally, one can produce the same brain lesions using hydrolysed vegetable protein as by using MSG or aspartate.<sup>14</sup>

A growing number of excitotoxins are being discovered, including several that are found naturally. For example, L-cysteine is a very powerful excitotoxin. It is now added to certain bread doughs and is sold in health food stores as a supplement. Homocysteine, a metabolic derivative, is also an excitotoxin.<sup>15</sup> Interestingly, elevated blood levels of homocysteine were recently shown to be a major, if not *the* major, indicator of cardiovascular disease and stroke. Equally interesting is the finding that elevated levels of homocysteine are also implicated in neurodevelopmental disorders, especially anencephaly and spinal dysraphism (neural tube defects).<sup>16</sup> (It is thought that there is a protective mechanism of action associated with the use of the prenatal vitamins B12, B6 and folate when used in combination.) It remains to be seen if the toxic effect is excitatory or due to some other mechanism. If it is excitatory, then unborn infants would be endangered as well by

glutamate, aspartate (part of the aspartame molecule) and the other excitotoxins. Recently, several studies found that all Alzheimer's patients examined had elevated levels of homocysteine.<sup>17</sup>

One interesting study found that persons affected by Alzheimer's disease also have widespread destruction of their retinal ganglion cells.<sup>18</sup> Interestingly, this is the area found to be affected when Lucas and Newhouse discovered the excitotoxicity of MSG. While this does not prove that dietary glutamate and other excitotoxins cause or aggravate Alzheimer's disease, it is powerful circumstantial evidence. When all of the information known concerning excitatory food additives is analysed, it is hard to justify continued approval by the FDA for the widespread use of these additives.

#### THE EFFECTS OF TOXIC FREE RADICALS

It is interesting to note that many of the same neurological diseases associated with excitotoxic injury are also associated with accumulations of toxic free radicals and destructive lipid oxidation products.<sup>19</sup> For example, the brains of Alzheimer's disease patients

have been found to contain high concentrations of lipid peroxidation products and evidence of free radical accumulation and damage.<sup>20, 21, 22</sup>

In the case of Parkinson's disease, we know that one of the early changes is the loss of one of the primary antioxidant defence systems, glutathione, from the neurons of the striate system and especially in the substantia nigra.<sup>23</sup> It is this nucleus that is primarily affected in this disorder. Accompanying this, is an accumulation of free iron, which is one of the most powerful free radical generators known.<sup>24</sup> One of the highest concentrations of iron in the body is within the globus pallidus and the substantia nigra. The neurons within the latter are especially vulnerable to oxidant stress because the catabolic metabolism of the transmitter, dopamine, can proceed to the creation of very powerful free radicals; that is, it can auto-oxidise to peroxide, which is normally detoxified by glutathione. As we have seen, glutathione loss in the substantia nigra is one of the earliest deficiencies seen in Parkinson's disease. In the presence of high concentrations of free

**Unfortunately for the consumer, the corporate food processors not only continue to add MSG to our foods but go to great lengths to disguise these harmful additives.**

**For example, they use such names as "hydrolysed vegetable protein", "vegetable protein", "textured protein", "hydrolysed plant protein", "soy protein extract", "caseinate", "yeast extract" and "natural flavouring".**

iron, the peroxide is converted into the dangerous and very powerful free radical, hydroxide. As the hydroxide radical diffuses throughout the cell, destruction of the lipid components of the cell takes place—a process called "lipid peroxidation". Of equal importance is the generation of the powerful peroxy radical, which has been shown to produce serious injury in cellular proteins and DNA, both mitochondrial and nuclear.<sup>25</sup>

Using a laser microprobe mass analyser, researchers discovered that iron accumulation in Parkinson's disease is primarily localised in the neuromelanin granules (which gives the nucleus its black colour).<sup>26</sup> Other studies showed that there is dramatic accumulation of aluminium within these granules.<sup>27</sup> Most likely, the aluminium displaces the bound iron, releasing highly reactive free iron. It is known that even low concentrations of aluminium salts can enhance iron-induced lipid peroxidation by almost an order of magnitude. Further, direct infusion of iron into the substantia nigra nucleus in rodents can induce a parkinsonian syndrome and a dose-related decline in dopamine. Recent studies indicate that individuals having Parkinson's disease also have defective iron metabolism.<sup>28</sup>

Another early finding in Parkinson's disease is the reduction in complex I enzymes within the mitochondria of this nucleus.<sup>29</sup> It is well known that the complex I enzymes are particularly sensitive to free radical injury. These enzymes are critical to the production of cellular energy. As we shall see, when cellular energy is decreased, the toxic effect of excitatory amino acids increases dramatically.

In the case of ALS, there is growing evidence that similar free radical damage, most likely triggered by toxic concentrations of excitotoxins, plays a major role in the disorder.<sup>30</sup> Several studies demonstrated lipid peroxidation product accumulation within the spinal cords of ALS victims, as well as iron accumulation.<sup>31</sup>

It is now known that glutamate acts on its receptor via a nitric oxide mechanism.<sup>32</sup> Overstimulation of the glutamate receptor can produce an accumulation of reactive nitrogen species, resulting in the generation of several species of dangerous free radicals, including peroxy radical. There is growing evidence that, at least in part, this is how excess glutamate damages nerve cells.<sup>33</sup> In a multitude of studies, a close link was demonstrated between excitotoxicity and free radical generation.<sup>34-37</sup>

Other studies showed that certain free radical scavengers (antioxidants) successfully block excitotoxic destruction of neurons. For example, vitamin E is known to block glutamate toxicity completely *in vitro*.<sup>38</sup> Whether it is as efficient *in vivo* is not known. But it is interesting in the light of recent observations that vitamin E, combined with other antioxidant vitamins, slows the course of Alzheimer's disease and is suggested to reduce the rate of advance in a subgroup Parkinson's disease as well.

In the Datatop study of the effect of alpha-tocopherol alone, no reduction in disease progression was seen. The problem with this study was the low dose that was used and the fact that the DL-alpha-tocopherol used is known to have a much lower antioxidant

potency than D-alpha-tocopherol. Stanley Fahn found that a combination of D-alpha-tocopherol and ascorbic acid in high doses reduced progression of the disease by 2.5 years.<sup>39</sup> Tocotrienol may have even greater benefits, especially when used in combination with other antioxidants. There is some clinical evidence, including my own observations, that vitamin E, especially in the form of D-alpha-tocopherol, also slows the course of ALS. I would caution that antioxidants work best in combination, and that when used separately can have opposite, harmful effects. That is, when antioxidants, such as ascorbic acid and alpha-tocopherol, become oxidised themselves—such as in the case of dehydroascorbic acid—they no longer protect, but rather act as free radicals themselves. The same is true of alpha-tocopherol.<sup>40</sup>

Again, it should be realised that excessive glutamate stimulation triggers a chain of events that in turn sparks the generation of large numbers of free radical species, both as nitrogen and oxygen. These free radicals have been shown to damage cellular proteins (protein carbonyl products) and DNA. The most immediate DNA damage is to the mitochondrial DNA, which controls protein expression within that particular cell and its progeny, producing rather profound changes in cellular energy production. It is suspected that at least some of the neurodegenerative diseases, Parkinson's disease in particular, are affected in this way.<sup>41</sup> Chronic free radical accumulation would result in an impaired functional reserve of antioxidant vitamins, minerals, enzymes and thiol compounds necessary for neural protection. Chronic unrelieved stress, chronic infection, free-radical-generating metals and toxins, and impaired DNA repair enzymes all add to this damage.

We know there are four main endogenous sources of oxidants:

1. Those produced naturally from aerobic metabolism of glucose.
2. Those produced during phagocytic cell attack on bacteria, viruses and parasites, especially with chronic infections.
3. Those produced during the degradation of fatty acids and other molecules that produce  $H_2O_2$  as a by-product. (This is important in stress, which has been shown to increase brain levels of free radicals significantly.)
4. Oxidants produced during the course of p450 degradation of natural

toxins. And, as we have seen, one of the major endogenous sources of free radicals is from the exposure of tissues to free iron, especially in the presence of ascorbate. Unfortunately, iron is one mineral heavily promoted by the health industry, and is frequently added to many foods, especially breads and pastas. Copper is also a powerful free radical generator and has been shown to be elevated within the substantia nigra of parkinsonian brains.<sup>42</sup>

What has been shown in all these studies is a direct connection between excitotoxicity and free radical generation in a multitude of diseases and disorders such as seizures, strokes, brain trauma, viral infections and neurodegenerative diseases.

Interestingly, free radicals were shown to prevent glutamate

**What has been shown in all these studies is a direct connection between excitotoxicity and free radical generation in a multitude of diseases and disorders such as seizures, strokes, brain trauma, viral infections and neurodegenerative diseases.**

**Continued on page 81**





# DEADLY SOUNDS

## DR GAVREAU'S INFRASONIC WEAPON

*Observations of the harmful effects of infrasonic vibrations led French robotics scientist Dr Vladimir Gavreau to develop infrasound detectors, weapons and shields.*

by Gerry Vassilatos © 1996

from chapter 8 of his book  
**LOST SCIENCE**  
published in 1998 by  
Borderland Sciences Research  
Foundation  
PO Box 6250  
Eureka, CA 95502, USA  
Website: [www.borderlands.com](http://www.borderlands.com)

It was masterfully macabre: black foundations, blue pillars and rainbow ceilings; sound, rhythm and space. Ultra-chromatic chord frames rose like rock walls from the black depths, and immense stellar crystallisations radiated tonal perfumes through deep, black, radiant space. Lovely, lyrically swooping melodies reached up towards unknown depths of space. Each had its foundation in ultrabass tones of rooted depth. The *basso profundo* of Messiaen was the critical foundation, supporting the strong pillars of an immense architecture which extends beyond performance walls.

Olivier Messiaen, the master composer, used the ground-thrumming tones of great Parisian cathedral organs to evoke sensations which may only be called otherworldly. He scoured the deep and unreachable roots of worlds to hold his musical cathedrals together. Such majesty and grandeur of sound! It was rich in the intelligence which flooded and made the world, the musical currents and the atmosphere of tones; fluidic music and meaning.

Yet, the most fundamental signals which permeate this world are inaudible. They not only escape our hearing, but they undergird our being. Natural infrasounds rumble through our experience daily. Their manifestations are fortunately infrequent and incoherent. Infrasound is inaudible to human hearing, being of pitch below 15 cycles per second—the bottom human limit, the plinth, the foundation. Infrasound is not heard, it is felt. Infrasound holds a terrible secret in its silent roar.

Infrasound produces varied physiological sensations which begin as vague "irritations". At a certain pitch, infrasound produces physical pressure; at specific low intensity, it produces fear and disorientation. Nazi propaganda engineers methodically used infrasound to stir up the hostilities of crowds who were gathered to hear their madman. The results are historical nightmares. At a very specific pitch, infrasound explodes matter; organisms rupture in its blast. At other pitches, infrasound incapacitates and kills. Sea creatures use this power to stun and kill prey.

The swelling bass tones of the cathedral seem as though they can burst the very pillars which uphold the vaults. Stained glass windows have been known to erupt in a shower of coloured fragments from the organ's *basso profundo*. Somewhere in the almost inaudible roll of these basement sounds, these impulsive ultrabass tones, this thunder, there was a devastating and fearful power.

### INFRASOUND GENERATED BY NATURAL PHENOMENA

Natural phenomena—thunder, earthquakes, volcanic eruptions, ocean waves, waterfalls, winds and auroras—are prodigious generators of infrasound.

The potent distal effects produced when natural explosions occur produce legendary effects. When Krakatoa exploded, windows were shattered hundred of miles away by the infrasonic wave. The "ringing" of both earth and atmosphere continued for hours. It is believed that infrasound actually formed the upper pitch of this natural volcanic explosion, tones unmeasurably deep forming the actual "central harmonic" of the event. The island of Krakatoa was literally lifted into orbit in the fatal blast.

Analysts contend that infrasound is composed of a very broad band of pitches. These tones of immense pressure and duration "accommodate" themselves when encountering resonant cavities. All such resonant cavities are "found and destroyed" when the proper pressure waves flow into their resonances. Infrasound is the cruel tonal giant, tearing open whatever it finds in its path.

Studies reveal that the sudden shock of an explosion propels a complex infrasonic

signal far beyond the shattered perimeter. Incoherent though such shockwaves may be, their destructive influence dissolves distant walls and windows seconds after the shrapnel has done its deadly work. Objects of all shapes, sizes and compositions explode when the infrasonic impulse passes through their space. No shield can block infrasound. Physicists have studied the refuse which remains after an explosive charge has been detonated. Few materials can maintain their integrity. Those objects which manage to survive explosions are noteworthy as infrasonic "resistors". Screen-reinforced concrete does not easily succumb to the infrasonic blasts of explosive charges.

Certain earthquake activities produce large and virtually insensate vertical displacements of the ground surface, in extreme instances amounting to a few feet per pulse. In this case, the ground becomes like the surface of a drum, ringing out its deadly cadence at infrasonic pitch, hours before the event. The ground undulates with infrasonic tones, an elasticity that eventually cracks under the heaving stress.

These ultralow-pitch earthquake sounds are keenly felt by animals and sensitive humans. Indeed, infrasonic shocks produce characteristic pressure effects on structures and organisms alike.

The sensation flattens the body; it is as if one were struck with a solid invisible wall from which there is no escape. Anxiety, fear, extreme emotional distress and mental incapacitation are all part of the unpleasant phenomenon. Notable among human exposures to quake-correlated infrasound is the precursory nausea which many report; this strong sensation leaves its more sensitive victims helpless.

Ocean waves which pound the atmosphere across huge areas produce an acoustic energy with a mean pitch of 16 cycles per second. The phenomena of "barisal guns", "fog guns" and "lake guns" form a well-documented bibliography of anomalous acoustic phenomena. Some of these "booming" tones manifest at haphazard intervals, but others are periodic. Bay sizes, wave sizes, the geologic compositions of bays and shores have been woven into complex mechanistic attempts at explaining how these mystery sounds are being generated in certain environments. These natural bay tones have great infrasonic content. These booming sounds have rattled windows and rocked some small towns.

However, mysterious and sudden barometric variations indicate that natural infrasonic generation has a much wider source than the subterranean earth or bodies of water. Both solar flares and the normal thrummings of the solar wind generate infrasonic pulses throughout the atmosphere. Aerial earthquake sounds have been reported by observers. Typical of infrasound, the sources cannot be accurately located. The high-pitched sizzling sounds of the aurora borealis are augmented by deep and ominous thrumming. These deep tones sweep through the bodies of listeners, and these permutations produce an irritability and a dizzying nausea. The infrasonic shockwaves of the aurora are normally not heard, but definitely sensed.

Infrasound moves, unaffected, through and across both winds and storms, but these too can generate infrasound. The powerful harmonic rotations of storms shear the atmosphere, radiating a cyclonic series of expanding infrasounds. The sense of impending fear which precedes hurricanes is due to infrasonic emissions.

The infrasound of seasonal winds and weather patterns produces illness in certain persons. Symptoms include anxiety and depression, emotional tension, irritability, disorientation, accident-proneness, nausea and diarrhoea.

Infrasound travels long distances with virtually no attenuation. Its pressures thus arrive at great distances with the same force and intensity as when generated. The atmosphere sustains prolonged and powerful infrasonic vibrations. Not much acoustic power is required for infrasound to produce such extreme and sustained physiological and psychological symptoms.

## EFFECTS OF MACHINE VIBRATIONS

Vibrating man-made structures stimulate the artificial generation of dangerous infrasound. When turns are made at 60 miles per hour [96.6 kph], car chassis vibrations produce a peak infrasonic emission. Travel sickness can be associated with prolonged infrasonic exposure to any vibrating chassis. Cars, buses, trains, motorcycles and jets alike, each register hazardous intensities of infrasound. Each transportation mode has its characteristic infrasonic pitch, the necessary outcome of mechanical frictions and inertial resistances.

There is difficulty in recording and reproducing ultradeep tones for study and analysis. They have to be generated on site for experimental purposes. Theatre-sized sound systems can never completely transmit all of the sensations associated with naturally occurring infrasound. But there have been instances where audiences have become frighteningly ill because of the accidental generation of infrasound in a theatre space.

Of critical importance is the comprehension of human tolerances to infrasound. Military medical teams have long studied the effect of

machine vibration on human judgement and behaviour out of necessity. If jet pilots and rocket pilots alike evidence even minor errors in judgement through their exposure to infrasound, disaster can result. Certain critical errors in judgement and accuracy have in fact been noted during short flight times.

The powerful infrasonic vibrations of jet chassis absolutely saturate the bodies of pilots. Continually saturated with these infrasonic energies throughout their flight time, pilot reflexes are severely diminished. Military procedure recognises this factor, and routinely limits flight time. It is known that excess infrasonic exposures endanger pilots and their flight missions. Pilot-damaging effects include decrements in vision, speech, intelligence, orientation, equilibrium and the ability to discern situations accurately and make reasonable decisions.

## DEADLY COLD WAR WEAPONRY

The Cold War was on. The United States alone held the dreaded secret. The most terrible weapon yet developed was the private property of one government. The mere existence of the atomic bomb was a threat to nations whose motives were not entirely altruistic.

Obtaining atomic bomb data was a priority for several motivated, aggressive and imperialistic nations. The only manner in which some nations obtained the secret was by stealing it. When Stalin's science officers finally developed a duplicate of the American atomic bomb, pressure suddenly was placed upon every

**Objects of all shapes, sizes and compositions explode when the infrasonic impulse passes through their space. No shield can block infrasound.**

other European nation to create an equivalent or better device.

When one seeks to defend one's borders, the consequences of releasing weapons of devastation to the world do not seem important. Weaponry is death-oriented by nature. But there are moral differences between weapons of defence and weapons of offence.

Previous to this atomic proliferation, competing nations concentrated their weapons research on truly bizarre and equally deadly means for defending their national boundaries. Perfected in rapid succession were deadly variations and combinations of gas weaponry, pathogenic agents and radiant weaponry. Stalin's research teams investigated psychic powers as a possible means of destroying an enemy. Psychotronic warfare was developed among numerous groups, both private and national, with measurable success. Information on some simpler psychotronic weapons has recently been obtained through an increasing process of Soviet disclosure.

In truth, the larger the weaponry, the less safe were the national boundaries. While the superpowers concentrated their weapons development programs on mass-destructive nuclear weaponry, others focused on more practical, conventional weapons which seemed to fill an immediate need in the limited tactical warfare of small battlefields.

While developing its own atomic device, France sought defensive tactical weaponry on every possible technological front. Short-range weapons would best defend against a conventional national assault. But other systems were also sought—systems which, though non-nuclear, were equally invincible. As the great mediaeval Frankish knight Charles "the Hammer" Martel repelled ruthless invaders from the East, so a new hammer would be sought to defend France against possible new enemies. Even as Charles Martel arose from obscurity, so this strange new "hammer" would arise in equal obscurity.

#### **DR VLADIMIR GAVREAU**

The central research theme of Dr Vladimir Gavreau was the development of remote-controlled automatons and robotic devices. To this end, he assembled a group of scientists in 1957 [at the Electro-Acoustical Laboratory in Marseille, France]. The group, including Marcel Miane, Henri Saul and Raymond Comdat, successfully developed a great variety of robotic devices for industrial and military purposes.

In the course this development, Dr Gavreau and his staff made a strange and astounding observation which not only interrupted their work but became their major research theme. Housed in a large concrete building, the entire group periodically experienced a disconcerting nausea, often day after day, for weeks at a time. Industrial examiners who were called to inspect the situation also fell victim to the malady. It was thought that the condition was caused by pathogens—a "building sickness". No such biological agencies were detected, yet the condition prevailed. Their research schedules now seriously interrupted, the team called for a complete examination of the building.

The researchers had noticed that the mysterious nausea ceased when certain laboratory windows were blocked. It was then assumed that "chemical gas emissions" of some kind were respon-

sible for the malady, and so a thorough search of the building was undertaken. While no noxious fumes could be detected by any technical means, the source was finally traced by building engineers to an improperly installed motor-driven ventilator. The engineers at first thought that this motor might be emitting noxious fumes, possibly evaporated oils and lubricants, but no evaporated products were detected. They then found that the loosely supported low-speed motor, poised in its cavernous duct of several storeys' height, was developing "nauseating vibrations".

The mystery magnified for Dr Gavreau and his team when they tried to measure the sound intensity and pitch. Failing to register any acoustic readings at all, the team doubted the assessment of the building engineers. Nevertheless, closing the windows blocked the sense of nausea.

In a step of brilliant scientific reasoning, Gavreau and his colleagues realised that the sound they were dealing with was so low in pitch that it could not register on any available microphonic detector. This was costly to the crew; they could not pursue the "search" for long time-periods. In fact, during the very course of tracking down the sound, an accidental direct exposure rendered them all extremely ill for hours.

When they finally managed to measure the "sound", they found that a low-intensity pitch of a fundamental seven cycles per second was being produced. Furthermore, this infrasonic pitch was not one of great intensity. It became obvious that the slow-vibrating motor was activating an infrasonic resonant mode in the large concrete duct.

Operating as the vibrating "tongue" of an immense "organ pipe", the rattling motor produced nauseating infrasound. Coupled with the rest of the concrete building—a cavernous industrial enclosure—the vibrating air column formed a bizarre infrasonic amplifier.

Knowledge of this infrasonic configuration also explained why shutting the windows was mildly effective in "blocking the malady". The windows altered the total resonant profile of the building, shifting the infrasonic pitch and intensity.

Since this time, others have noted the personally damaging effects of such infrasonic generation in office buildings and industrial facilities. The nauseating effects of exposure to a low-intensity natural or man-made infrasonic source is now well appreciated. It has become a routine architectural procedure to seek out and alter any such possible resonant cavities. The sources often appear in older buildings, the result of construction rendered faulty by previous lack of this knowledge. All such "improper" architectural formats are modified by the addition of sound-blocking materials.

#### **EXPERIMENTS WITH INFRASONICS**

Dr Gavreau and his research team now carefully investigated the effects of their "infrasonic organ" at various intensity and pitch levels. By changing the spring tension on the shock mounts which held the fan motor, it was possible to change the pitch. Various infrasonic resonances were established throughout the large research building. Shutting the windows blocked most of the symptoms, but opening them again, however weak was the

**Gavreau and his colleagues realised that the sound they were dealing with was so low in pitch that it could not register on any available microphonic detector.**

source, made the team feel the nauseating effects once more.

In the business of military research, Dr Gavreau believed he had discovered a new and previously "unknown weapon" in these infrasounds. Aware of the natural explosives by which infrasonics are generated, Dr Gavreau began to speculate on the application of infrasonics as a defence initiative. The haphazard explosive effects of natural infrasound in thunderclaps were quite effective in demonstrating what an artificial "thunder-maker" could do—but how could a thunderclap be artificially generated in a compact system? These thoughts stimulated theoretical discussions on the possibility of producing coherent infrasound—an infrasonic "laser".

The first devices Dr Gavreau implemented were designed to imitate the "accident" which first made his research group aware of infrasonics. The team designed real organ pipes of exceedingly great width and length, the first of these being six feet in diameter and 75 feet long. Two forms of these infrasonic organ pipes were built: the first utilised a drive piston which pulsed the pipe output, while the second utilised compressed air in a more conventional manner. These designs were tested outdoors, securely propped against protective sound-absorbent walls, while the investigators stood at a great distance.

The main resonant frequency of these pipes was found to be in the "range of death", between three and seven cycles per second. These sounds could not be humanly heard—a distinct advantage for a defence system. However, the effects could be felt.

Even though the pipes were operating for only a few seconds, symptoms in the investigators came on rapidly and unexpectedly. The pressure waves impacted against the entire body in a terrible and inescapable grip—a pressure which came in on the body from all sides simultaneously, an envelope of death. Next came the pain—dull, infrasonic pressure against the eyes and ears. Then came a frightening manifestation on the material supports of the device itself. With sustained operation of the pipes, a sudden rumble rocked the area, nearly destroying the test building. Every pillar and joint of the massive structure moved. One of the technicians managed to ignore the pain enough to shut down the power supply.

These experiments with infrasonics were as dangerous as those early investigations of nuclear energy, but infrasonic assaults on the body are the more lethal because they come with a dreadful silence. Dr Gavreau and his associates were dangerously ill for nearly a day after these preliminary tests were performed. Their eyesight was affected for days. More dangerously, their internal organs were affected: the heart, lungs, stomach and intestinal cavity were filled with continual painful spasms for an equal time period. Musculature convulsions, torques and tears were the symptoms of their infrasonic exposure. All the resonant body cavities absorbed the self-destructive acoustic energy, and would have been torn apart had the power not been extinguished at that precise moment.

The effectiveness of infrasound as a defensive weapon of frightening power having been demonstrated "to satisfaction", more questions were asked. After this dreadful accident, approaching the equipment once again was almost a fearful exercise. How powerful could the output of an infrasonic device be

before it affected even the operating engineers?

With greatest caution and respect for the power with which they worked, Dr Gavreau began recalculating all of his design parameters. He had grossly misjudged the power released by the pipes; in fact, he had greatly lowered those calculated outputs for diagnostic purposes. Never had he imagined that these figures were actually far too great in the world of infrasound!

Empirical data collection and analysis being the only way to determine how infrasonic energy correlated with both biological and material effects, the tests were again attempted with a miniature power supply. First, the dimensions of these devices had to be greatly reduced; their extreme length was objectionable. In order to provide absolutely safe control of the deadly blasts, several emergency cut-off switches were provided. These responded to the radiated infrasonic pressure wave. The intensity could be limited by the use of automated barometric switches.

In an attempt to produce more compact and controllable infrasound generators, Dr Gavreau designed and tested special horns and whistles of various volumes. These were each remarkably simple, flat, circular, resonant cavities, having a side output duct. They were simply the large analogues of foghorns and police

whistles. These flat forms were volumetrically reduced in successive design stages because it was found that their output was far too great. The infrasonic foghorns could produce a frightening two kilowatts of infrasonic energy at a pitch of 150 cycles per second. The flat "police whistles" were more easily designed to the required specifications. Their overall characteristics were quite simple to determine, a mathematical formula being devised for the purpose. The whistle's resonant pitch was found by dividing its diameter into a numerical constant of fifty-

one. Increasing the depth of the whistle effectively increased its amplitude. A whistle 1.3 metres in diameter produced an infrasonic pitch of 37 cycles per second. This form violently shook the walls of the entire laboratory complex, though its intensity was less than two watts of infrasonic power.

#### TESLA'S RESEARCH AND MILITARY MEDICAL TESTS

Not much amplitude is required for infrasound to produce physiological malady. Several researchers accidentally did themselves great harm when, either by deliberate intent or accident, they succeeded in generating infrasonic vibrations.

Dr Nikola Tesla used vibrating platforms as an aid to vitality. He delighted in "toning the body" with vibrational platforms of his own design. Mounted on heavy rubber pads, these platforms were vibrated by simple, motorised, "eccentric" wheels. Their mild use, for a minute, could be pleasantly stimulating, the effects invigorating the whole body for hours thereafter. However, their excessive use would produce grave illness, extreme aggravations of the heart being the most dangerous aspect of the stimulation. The entire body would "ring" for hours with an elevated heart rate and greatly stimulated blood pressure. The effects could be deadly.

In one historic instance, Samuel Clemens, Tesla's close friend, refused to descend from the vibrating platform after repeated warnings. Tesla was sorry he had allowed him to mount it, but his concern was drowned out by both the vibrating machine and Clemens's jubilant exaltations and praises. Several more seconds

**These experiments with infrasonics were as dangerous as those early investigations of nuclear energy, but infrasonic assaults on the body are the more lethal because they come with a dreadful silence.**

and Clemens nearly soiled his white suit. The effects of the infrasound were duly recorded.

Tesla often went to great lengths in describing the effects of infrasound to newspaper reporters who, behind his back, scoffed at the notion that a "little sound" could effect such devastation. Yet, it was precisely with such "little sound" that Tesla nearly brought down his laboratory on Houston Street. His compact infrasonic impulsive weapons were terribly efficient. Tesla later designed and tested infrasonic impulse weapons capable of wrecking buildings and whole cities on command.

Walt Disney and his artists were once made seriously ill when a sound effect, intended for a short cartoon scene, was slowed down several times on a tape machine and amplified through a theatre sound system. The original sound source was a soldering iron, whose buzzing 60-cycle tone was lowered five times to 12 cycles. This tone produced nausea in the crew, which lasted for days.

Physiology seems to remain paralysed by infrasound.

Infrasound stimulates middle ear disruptions, ruining organismic equilibrium and immobilising its victims. The effect is like severe, prolonged seasickness. Restoration to normal vitality requires several hours or even days. Exposure to mild infrasound intensities produces illness, but increased intensities result in death.

Alarming responses to infrasound in the 40 to 100 cycles range have been accurately recorded by military medical experts, and the results are sobering. As infrasonic pitches decrease, the deadly symptoms increase. Altered cardiac rhythms, with pulse rates rising to 40 per cent of their rest values, are the precursors to other pre-lethal states. Mild nausea, giddiness, skin flushing and body tingling occur at 100 cycles per second. Vertigo, anxiety, extreme fatigue, throat pressure and respiratory dysfunction follow. Coughing, severe sternal pressure, choking, excessive salivation, extreme swallowing pains, inability to breathe, headache and abdominal pain occur between 60 and 73 cycles per second. Post-exposure fatigue is marked. Certain subjects continue to cough for half an hour, while many continue the skin-flush manifestation for up to four hours. Significant visual acuity decrements are noted when humans are exposed to infrasound between 43 and 73 cycles per second. Intelligibility scores for exposed persons fall to a low of 77 per cent of their normal scores. Spatial orientation becomes completely distorted. Muscular coordination and equilibrium falter considerably. Depressed manual dexterity and slurred speech have been noted before individuals black out. Just before this point, a significant loss in intelligibility is noted.

The findings of Dr Gavreau in the infrasonic range between one and 10 cycles per second are truly shocking. Lethal infrasonic pitch lies in the seven-cycle range. Small amplitude increases affect human behaviour in this pitch range. Intellectual activity is first inhibited, blocked and then destroyed. As the amplitude is increased, several disconcerting responses occur as a result. These responses begin as complete neurological interference. The action of the medulla is physiologically blocked; its autonomic functions cease.

**Physiology seems to remain paralysed by infrasound. The effect is like severe, prolonged seasickness. Restoration to normal vitality requires several hours or even days. Exposure to mild infrasound intensities produces illness, but increased intensities result in death.**

## EXPERIMENTS WITH INFRASOUND DETECTORS

Infrasound clings to the ground, a phenomenon well known in the animal world. Female vocalisations and those of their young take their traceable routes through the air. High-pitched sounds are aerial in nature. This means that females and their young are natural targets for predators. Low-pitched tones cling to the ground, being "guided" along the soil layers. Male sounds cannot be localised by predators because they "hug" the ground, diffusing out from their source. Some males rumble the ground with their calls and hooves. These are communications signals which they alone comprehend.

The fact that the ground draws and guides low-frequency tones is a remarkable gift to the animal kingdom, enhancing the survival of male leaders. When herds are attacked by predators, the males can continue to give guidance to their companions, while remaining completely "invisible" and elusive. Predators cannot locate the calls and rumblings of male leaders because their low-pitched signals are impossible to pinpoint. They are therefore also impossible to attack. Predators are often overtaken by the males who maintain their diffusive communications across and through the ground.

The same analogies would apply to an infrasonic defence system. First, infrasound does not lose its intensity when travelling very long distances across the ground; it remains at the same intensity as when released from its deadly source. Also, because of the ground-clinging effect, infrasonic sources cannot be located without special appliances. This would work well for

those who used the weaponry of infrasound. But suppose some hostile force was itself using infrasonics? Infrasonics are inaudible. The battle would be over before anyone knew it had begun. How would one know of an infrasonic attack? The first line of defence therefore would be the detection of the "unperceived enemy". The development of an adequate infrasonic weapons systems would first require an infrasound detector.

Dr Gavreau first concentrated on developing infallible infrasonic detectors for the personal safety of his oper-

ators, and then for eventual tactical deployment. He experimented with several designs which followed the arcane analogues of old wireless detectors. One such design used enclosed flames to detect infrasonic pitches. They were reminiscent of those flame detectors developed by Lee de Forest just before his invention of the triode. Gavreau's flame detectors employed variable resonant cavities, the flame amplitudes shifting with specific infrasonic pitches. He could calibrate the infrasonic intensity as well as the pitch with these detectors. But flames are dangerous and fickle, and not very reliable in battle.

Dr Gavreau next experimented with enhanced mechanical barometers. These coupled large resonant cavities with very fine barometer tubes. They displayed great sensitivity. Steady increases in barometric pressure were registered when large cavity bellows were compressed by infrasound. The sensitivity of these barometers increased as the bellows' capacity was increased. They were adequate, but frail.

Another embodiment resembled the early mechanical television designs of John Logie Baird. It utilised large timpani skins, mirrors, lights and photocells. A mirror was fastened to the timpanum, and a light beam would flicker when infrasound struck the mirror. The photocell recorded these flickers as an electrical signal. This detector system was very reliable.

By far the most advanced detectors which Gavreau designed and tested utilised an electrolytic process. In this analogue of systems developed by Fessenden to measure faint wireless signals, chemical solutions and fine wirepoint electrical contacts were used. Chemical solutions, separated by an osmotic barrier, were forced to migrate through the barrier whenever infrasound traversed the system. This chemical mixture was then measured as an increased electrical conductivity in a sensitive galvanometer. This system was reliable and accurate.

However, all of these systems suffered from one problem: the offensive use of an incredible infrasonic amplitude would burst them into vapour.

## DEFENCE AGAINST INFRASOUND

Statements were issued by the French authorities, to the effect that Dr Gavreau was not developing weapons at all. Several patents, however, betray this conspicuous smokescreen. While it is impossible to retrieve the actual patents for the infrasonic generators, Dr Gavreau is credited with extensive development of "infrasonic armour". Why would he "waste" such time and expense if not for an anti-weapons program?

Thus use of infrasonic weaponry necessitates the development and implementation of infrasonic shields. Dr Gavreau spent more time developing infrasonic shields than on developing efficient infrasonic horns. Infrasound could not be blocked adequately, as Dr Gavreau discovered early in his research. Infrasonic devices require extremely large baffles. Furthermore, no one would dare initiate an infrasonic barrage on any invasive force without adequate protection. Infrasonic horns can project their sounds in a given direction, but natural environments "leak" portions of the sound in all directions. Infrasonds saturate their generators, flooding and permeating their sources in a few seconds. They "work their way back" towards those who dispatch their deadly signals. Infrasonds "hug" the ground and spread around their sources. Unfortunately, those who would release infrasonic energy would themselves be slaughtered in the very act.

Gavreau's first method involved the conversion of infrasound into successively higher pitches until the infrasonic pitch was "lost". This was achieved in his passive "structural" method—an enormous, layered series of baffles and resonant cavities. This form is "passive", since it merely stands and waits for infrasonic barrages, absorbing and converting them into harmless audible tones.

His second method was more "aggressive", actively engaging and nullifying any offensive infrasonic power. The nullifier uses a well-known physical principle in its operation. As an "active" shield, it transmits tones whose opposing wavefronts destructively interfere with incoming infrasound. Infrasonic attacks are nullified, or at least brought to much weaker levels. This method requires high-speed detection and response systems. The process

involves determination of an attack pitch, generation of the same, and projection of the pitch "out of phase". The active nullifier method is not completely accurate or protective by any means. A highly modulated, mobile infrasonic source would be nearly impossible to neutralise successfully without extremely sophisticated electronics.

But Gavreau imagined an elegantly simple approach—one which would not require the defender to be exposed to his own infrasonic projections. While fixated on the old notion of gun installations and stations, Gavreau and the team had momentarily forgotten their first research endeavour: robotics!

## ROBOT-DELIVERED INFRASONIC WEAPONRY

Let us recall that Dr Gavreau and his team of pioneers were in the business of robotics, and developed industrial and military automaton systems. How difficult would it have been to couple his newfound weaponry with robotic applications?

Dr Gavreau combined the organ pipe and whistle format. The device was housed in a concrete block, less than a cubic metre in volume. The primary whistle was poised within its interior. At

its flared opening were placed several resonant pipes. The device was operated by highly compressed air, and its output was frightful. In a conventional engagement, it would be capable of utterly destroying an aggressor. For one experiment, this infrasound whistle set-up was sealed in an 880-pound [400-kg] concrete pier, with a concrete baffle placed over its projective end. Even with these precautions, the device succeeded in absolutely shaking a fan-shaped portion of Marseille. It broke through its supportive concrete pier and destroyed the baffle-covering in an

instant. Macabre! No sound was ever heard. This design demonstrated great pitch selectivity, power and directionality.

In this last feature, Gavreau and his team achieved a safety factor of greatest value. Infrasonic defensive armaments could now be safely directed away from the operators. This weapon was a remarkably compact and efficient device. Its efficiency was gauged by the destructive output and the weapon's volume.

A later embodiment of this terror disclosed another compact cube. The infrasonic whistle was presumably housed therein. Proceeding from the front plate were some 60 pipes, with flared horns aimed in a deadly forward array. It was said that this device alone, remotely guided into an arranged artificial battlefield, burst open heavy battlements and tank interiors with hideous effortlessness. In addition, several other more frightening and unmentionable disruptions of equal effectiveness were observed. In each instance, not a sound was heard.

The device was mounted on a mobilised robotic vehicle, powered by diesel engines or compressed gas. The almost insignificant unit would be a bizarre foe for an army to engage. As defensive weaponry, such a device would be terrible and effective. The system would be a true deterrent for those who would be foolish enough to attempt a ground assault on any nation so armed. Armies would fall flat. Once the infrasonic horns were unleashed against the foe, the battle would not even begin. Such a war engine would be impossible to locate. None

**Unfortunately, those who would release infrasonic energy would themselves be slaughtered in the very act.**

Continued on page 83





# SWIMMING THROUGH THE ETHER

## NOTES ON HOMOEOPATHY & RADIONICS

*Esoteric science provides a model for understanding how radionics and homoeopathy work in transmitting specific energy frequencies to effect healing.*

by Nick Franks © 2000

PO Box 93  
Wilmslow, Cheshire SK9 5FF, UK  
Fax: +44 (0)1625 549809  
E-mail: [nick@nicko500.co.uk](mailto:nick@nicko500.co.uk)  
Website: [www.nicko.com](http://www.nicko.com)

*We analyse the normal so that we may know the difference between it and the abnormal.*

— Dr Ruth Drown

### A VERY BRIEF HISTORY OF RADIONICS <sup>1</sup>

In the past few issues of *The Homoeopath*, there have been a number of references to dowsing. Nicholas Biggins's article, "Off with the Fairies" (issue 73, spring 1999), is an excellent description of how he has learned to use the pendulum to give him significantly improved results. Previous to this, the readership may have been surprised to discover that no less a person than Edward Whitmont would test his remedy selection by stroking a glass rod across the abdomen of his patient, looking for the reaction which would confirm its suitability (see tribute from Dana Ullman, issue 72, winter 1999).

Since its beginnings about 100 years ago, the relatively obscure science of Radionics has utilised various dowsing techniques,<sup>2</sup> not only to detect disease states but also to identify and apply appropriate therapies. Homoeopathic remedies are widely used in radionics, and some seminal personalities (such as John Damonte) in the present development of homoeopathy in Britain were also radionics practitioners. In this essay, I will give a brief overview of radionics and how radionic techniques may be of assistance in homoeopathic prescribing and also to our understanding of what remedies are and how they work.

Radionics was founded by Dr Albert Abrams (1863–1924), a native of San Francisco, under the original name of ERA—Electronic Reactions of Abrams. A highly qualified conventional practitioner with an illustrious career and also the advantage of a substantial private fortune, Abrams was able to pursue his researches without reliance on outside funding. Like Hahnemann, the founder of homoeopathy, he was a master of observation and a tireless experimenter and truth-seeker—attributes which eventually led him to make discoveries which brought considerable opprobrium from the medical establishment of the day. Like so many of these outstanding figures, he was also capable of making inspired leaps of judgement.

Abrams's fundamental discovery was that under certain conditions the human nervous system will react to the energy field of external elements such as persons with disease conditions, samples of diseased tissue and so forth. This reaction would manifest by means of a muscle reflex which could be detected by percussing the abdominal wall. Alternatively, Abrams found that drawing a glass rod across the abdomen could also be used to localise the point of response. Different diseases produced reactions in different parts of the abdomen, and, as Abrams noted, "drugs in homoeopathic dilutions can be detected and identified by the stomach reflex", which suggested a unique diagnostic method.

He then proceeded to develop a technique which placed a person (known as "the Subject"), with abdomen bared, in series with a patient, i.e., linked by a wire which terminated on the subject's forehead. He could then diagnose by testing on the healthy subject for response to disease conditions in the patient. Abrams later discovered that certain diseases produced reactions in the same muscle groups, which neatly threw his method off the rails until he hit upon the idea of placing a variable potentiometer (i.e., a rotary control such as might be used to adjust the volume on a hi-fi) in the middle of the cable linking the subject to the patient. Settings of the potentiometer would be found which were unique to each disease, thus making it possible to diagnose a wide range of conditions.

Eventually Abrams discovered that he could diagnose just as accurately using a blood sample from the patient, and he later found out that he could work at a distance with the

patient's sample placed next to the telephone line; such tests were performed over distances of more than 500 miles. He finally discovered that he could work without any form of linking wire between himself and the sample, but not over a distance of more than a mile.

From these basic elements—the reflex muscle reaction to the stimulus of an external energy field, the substitution of a sample from the patient for the patient himself, the creation of a unique value representing a disease or other energy factor, and the possibility of working at a distance—is formed radionics as we know it today.<sup>3</sup>

Dr Ruth Drown (1892–1963), a chiropractor based in Hollywood, USA, had apparently worked in Abrams's clinic as a young woman and decided to develop his methods. From the accounts I have read, she was clearly another remarkable figure.

Probably as a consequence of her successes and unwillingness to toe the line, the establishment persecuted her to the point of trial and eventual brief imprisonment. In fact, as a result of the Drown trial in 1951, it remains basically illegal, I believe, to practise radionics in the USA.

Drown redesigned the diagnostic instrument into a compact system which gave greater flexibility and extended range. The patient's blood sample was relocated into a small container in the instrument. She replaced the subject's abdomen with a small rubber membrane (known as the "stick pad"); the index finger was stroked along the pad while the potentiometers were adjusted, and when the appropriate setting was found—i.e., the circuitry came into balance, indicating a resonance or response in the practitioner—the finger would "stick" on the membrane.<sup>4</sup> Her new designs, incorporating a number of potentiometers in series, also allowed longer sequences of numerical values to be created, which enabled her to assemble an atlas of rates covering most of the structures in the human body, many disease types, poisons and toxins, and a range of other factors including emotional states.

Drown sought to define perfect structures, to measure the degree of deviation from perfection and then to rectify any imbalances or deficiencies. Thus, very simply, her rate for the liver is 48; this would be set on the instrument and the deviation from zero tested.<sup>5</sup> Any significant reading would indicate a problem either in the liver or elsewhere in the body which was affecting the liver. Her principal treatment method was to feed the "perfect" rate back to the respective diseased location in the patient, either by wires or remotely—the idea being that as new cells were created, they would be healthy and would replace the diseased structures. According to the information available, she claimed many successes. She also placed a priority on treating the endocrine system, and, as radionics emerges as a system of treatment on the dynamic plane, I will show how this ties in with the analysis of the subtle anatomy which has come to dominate present-day radionics, at least in the UK.

What is also of significance is Drown's use of the technique of treating at a distance—any distance, anywhere in the world—in

the process known as "radionic broadcasting". It was no longer necessary for the patient to be present. Incidentally, the term "broadcasting" is descriptive but probably inaccurate, as no radio or television technology is involved. Whatever the mechanism, there is no doubt in my mind that treatment-at-a-distance works, whether one is broadcasting homoeopathic remedies, radionic (i.e., Drown-type) rates or any other energy factor or vibrational pattern which can be represented as a radionic signature and is appropriate to the patient. Substance itself cannot be broadcast—at least not yet, as far as I know; otherwise we would be in the realm of the matter transporters which form such an integral part of *Star Trek* technology.

It would seem from the present-day position that virtually anything can be represented by a radionic rate, and this of course includes the entire *Materia Medica*. It is even possible, in principle, to find rates for remedies which we do not yet have or which are too dangerous to handle, such as radioactive materials. Malcolm Rae's ever-expanding system has around 24,000 rates which are presented in the form of ratio cards and include the whole acupuncture system of meridians and a vast range of chemicals, drugs, human organ functions, ayurvedic and I Ching concepts and so forth.

#### THE DEMATERIALISATION OF RADIONICS

Drown was also very involved in esoteric studies, notably of the Kabbala—which amongst other things attempts to explain the underlying structure of reality through the relationships between numbers—and she thus sought to find meaning in the radionic rates through kabbalistic interpretation. Whatever the result of this, she also thought that energy flowed from the universe into the human system via the brain, and that proper distribution of this energy was essential to healthy functioning; in other words, this was a move away from a purely physical conception of health and disease.

Just as Kent, influenced by Swedenborg, switched the focus of homoeopathic diagnosis to the mental and emotional planes and the realms of high-potency prescribing—and thus dematerialised homoeopathy—so Drown's esoteric line of thought was taken a huge step further by the work of David Tansley and Malcolm Rae (both men regrettably dying quite young).<sup>6</sup> Most of their work was done in the UK between approximately 1965 and 1985.

Tansley, a chiropractor, had spent many years studying the writings of Alice Bailey (1880–1949) and drew heavily on her concepts of esoteric anatomy and psychology in introducing a new diagnostic system which reoriented the focus of radionic analysis away from the material plane of organ functions and pathology and towards causation within the human energy (or subtle) body.

Bailey's work,<sup>7</sup> drawn from various Eastern traditions and integrated into a new form, is far too vast even to begin to attempt describing here, and I will simply create a thumbnail sketch of some of what has been appropriated into radionics. I might add that, as the years have gone by, various of these concepts have

**What is also of significance is Drown's use of the technique of treating at a distance—any distance, anywhere in the world—in the process known as "radionic broadcasting".**

become commonplace, but during the period the books were written, 1919–1949, they must have seemed like the last word in arcane obscurity.

Bailey proposed a model of (ultimate) reality as being comprised of seven planes of energy, each with its concomitant forms of consciousness. Each plane is comprised of seven sub-planes of increasing quality and fineness, the whole blending into a continuum. Each of these planes also manifests in us as a corresponding energy body, e.g., the etheric body, astral body and so forth.

Briefly, the 7th plane is the Physical, which is subdivided into the solid physical, then liquids, then gases, then four superior levels of etheric matter. It is the energy (*prana*) of the Etheric plane which vitalises the physical form. Tansley states that the "miasms" reside in the etheric body, and that when activated by an appropriate (morbific) stimulus they will taint the energy reaching the physical body, with results that Hahnemann described at length. (Hahnemann spent 12 years trying to understand why chronic disease exists, and concluded there must be some underlying disturbance which interferes with the vital force, producing chronic disease symptoms. Such miasms can be inherited or acquired.)

I should also note that energy is also distributed through the etheric body via a system of pathways known as *nadis*, and it may be considered that these in turn externalise as the nervous system.<sup>8</sup>

The 6th plane is the Astral (or Emotional)—the seat of emotions, desire and illusion, and also, with the Etheric, the place of origin of the greater number of diseases. The 5th plane is the Manasic (or Mental), the plane of mind, which ranges from concrete rational knowledge on its lower subplanes through to spiritual knowledge on its higher levels.

For the purposes of this article, it is not necessary to deal with the four higher planes—Buddhic (Intuitional), Atmic (Spiritual), Monadic and Logioic<sup>9</sup>—as they are not involved with the disease process. Tansley refers to them as the "transpersonal self" (or

perhaps "soul"), and I suppose you could consider them as the essential being of a person, whereas the lower vehicles are the becoming of a person—the deeper objective of life being to align the soul's purpose with that of the personality.

The link point between the transpersonal self and the personality is the higher ego or causal body. This is the vehicle found on the Mental plane, through which the individual manifests his or her purpose in existence. It is primarily friction<sup>10</sup> resulting from conflict between the different objectives of the higher and lower selves which creates illness and hence most<sup>11</sup> of the illnesses of humanity.

Compare this concept with §9 of Hahnemann's *Organon*: "In

the healthy human state, the spirit-like life force (autocracy) that enlivens the material organism as *dynamis*, governs without restriction...so that our indwelling, rational spirit can freely avail itself of this living, healthy instrument for the higher purposes of our existence."

Without arguing the finer points, it could be proposed that radionics and homoeopathy share a broadly similar central concept of the nature of human health.

Embedded in the subtle bodies are a number of energy transmission and circulation centres known as *chakras*,

which have their counterpart on each plane.<sup>12</sup> As the individual develops and consciousness reaches a higher level, so the chakras "open" and become receptive to energy flowing from higher and higher sources. Radionic analysis is principally concerned with the seven major chakras—the Base, Sacral, Solar Plexus, Heart, Throat, Brow and Crown—although certain minor chakras, such as the Spleen, are often taken into consideration. Each of these chakras, in turn, externalises as one of the endocrine glands, e.g., the Throat chakra corresponds with the thyroid gland, and the state of the chakra is considered to condition the functioning of the associated gland and local anatomy.

Seen in this context, the physical human is a precipitation of higher energies into form, and, as such, the quality of each

**Tansley states that the "miasms" reside in the etheric body, and that when activated by an appropriate (morbific) stimulus they will taint the energy reaching the physical body ...**

#### Endnotes

1. The best history of radionics is *Report on Radionics*, by Edward Russell (C.W. Daniel & Co, 1973, ISBN 85435-002-0). This is essential reading and includes fascinating material on agricultural radionics and the general techniques of weed and pest control without chemicals (suppressed in the USA in the 1950s by the chemical companies, according to Russell). Those of you who are against genetically modified (GM) foods and chemical agriculture, read it and weep.

2. Dowsing, sometimes known as radiesthesia, is a vast field of study predicated on the idea that everything has a unique energy signature which can be detected by a human sensitive using a means such as the divining rod or pendulum. The technique used merely serves to amplify the dowser's subconscious reaction which is transmitted to his or her arm muscles. Although the pendulum is considered to have no intrinsic power, I have

noticed that some pendulums seem to work better than others. I put this down to the fact that the material from which these are made may be incompatible with me in some way. I have also noticed that pendulums get "tired" and do not react as efficiently after continual use; which suggests that if a crystal gets overloaded, you will too—so in other words, be careful not to fatigue yourself. One recently published book recommended for beginners is *Anyone Can Dowse for Better Health*, by Arthur Bailey (1999, ISBN 0-572-02461-4).

3. Abrams also developed electronically based treatment procedures, but this promising line of work has, for the present, fallen into neglect and is outside the scope of this article. Nevertheless, it may bear some relation to what Dr Jacques Benveniste is currently researching; see his website, [www.digibio.com](http://www.digibio.com) [and refer to Science News in NEXUS 6/05. Ed.].

4. Present-day practitioners tend to use a hair

sample, and I think that the pendulum is now more widely used than the stick pad; it certainly gives a far greater range of responses.

5. See *The Drown Homa-Vibra Ray and Radio-Vision Instruments and Their Uses – Radionic Rate Book*. This and seminal works by Abrams and others have been republished by Borderland Sciences Research Foundation (BSRF) in California; see website [www.borderlands.com](http://www.borderlands.com).

6. For the sake of brevity, I am obliged to omit comment on important researchers such as George De La Warr (UK), T. Galen Hieronymous (USA) and Dr W. Guyon Richards (UK), to name but three. The trend of their work, however, does not materially affect what I am describing.

7. Bailey's work covers 24 volumes and is not a religion, system or dogma. The introduction to each volume basically says "Take it or leave it", or even "Take what you want and leave the rest". A starting point for those

structure, physical or subtle, will reflect the quality of the energy which has reached it. To put it another way, each structure will condition the energy flowing through it; hence, for example, the miasm in the etheric body taints the energy to produce some form of illness in the physical. Energy must flow freely through all of these systems into the physical body to make for the healthy human, and any disturbances of the subtle body will tend to interrupt the flow at some point and will be reflected in mental, emotional or physical symptoms of some nature.

Thus, the objective of radionic diagnosis is to find the energy disturbance at its source, if possible, and treat it appropriately.<sup>13</sup>

Again, this can be compared with §3 of *The Organon*: "...a physician must...clearly realise what is to be cured...in each single case of disease..."<sup>14</sup> In other words, we have to identify and rectify the causation; we will not deal with a polluted river (as it were) simply by cleaning it up downstream, if the source of the toxic material is in the higher reaches.

### RADIONIC AND HOMOEOPATHIC ANALYSIS

As I have noted, virtually anything can be represented by a radionic rate, and radionics is truly an open-ended system which enables a vast range of energy qualities and relationships to be studied.

The first step in radionic medical analysis is to discover the location, type and, if possible, reason for any deviation from proper function. The second step is to establish the nature of the relationship between the patient and an energy factor—for instance, the homoeopathic remedy—which may be used to correct the problem.<sup>15</sup>

The practitioner uses the instrument to create an overall picture of the patient's health and vitality by working through various levels and systems: the mental, emotional and etheric bodies, the aura and nadis, the chakras, and the physical systems as generalities, e.g., cardiovascular, respiratory, muscular, gastrointestinal tract and so forth. The influence or presence of miasms and the effects of vaccinations, poisons, toxins, geopathic stress, malignancies,

infections, allergies, nutritional deficiencies and other factors are also checked. The findings are marked onto a chart, and this enables a rapid assessment of the patient's general state to be made; any areas of difficulty should immediately be apparent. The type and source of the problem can be worked out either by mentally posing questions and watching the pendulum's response or by the use of additional charts. Again, each practitioner will tend to vary the basics according to his or her knowledge and experience. Radionics is not simply a "dumb" process of watching a pendulum move, as the key factor lies in knowing which questions to ask and how to interpret the responses. It should be apparent that both diagnosis and treatment are highly individualised, as in homoeopathy.

diagnosis and treatment are highly individualised, as in homoeopathy.

I suggest that the system of subtle bodies and chakras constitutes a model of the dynamis, or perhaps a model of what the life force must flow through (as, by analogy, electricity flows through a circuit) in order to result in a state of health in the individual; and that radionic methods can give the practitioner additional information to help the diagnosis and prescription and can even detect diseases before they manifest in the form of symptoms.<sup>16</sup>

Homoeopaths use the word "stuck"

when talking about cases, and another way of looking at the problem is to find out where the energy is stuck. In case-taking, we have the verbal description by the patient to guide us. In radionic analysis, we use a structured method of dowsing to locate the points where the energy is blocked. The description of the symptom by the patient, I have to suppose, is how he verbalises the symptoms he experiences as a result of the blocks in his subtle anatomy.

A counterpart idea to this is that the provings, rubrics and remedy pictures are records of the effect of the energy of a potentised substance on a healthy person, and the prescription is reached by a transposition of the patient's comments into the special diagnostic language of homoeopathy via a weighting system, through which the practitioner attaches greater or lesser significance to the patient's symptoms and then compares them with the rubrics in

I presume that the remedy cancels out some distortion in the patient's field and thus rectifies it, and this is later reflected in the removal of the symptoms.

interested might be *Esoteric Healing* (Lucis Press, 1953, ISBN 85330-121-2). Note that I have deliberately left out any mention of her system of Ray psychology because of space limitations.

**8.** There is considerable debate about the exact nature of the relationship between the nadis and the nervous system. As a therapeutic note, I am beginning to suspect that severe dysfunction of the nadis is a key factor in so-called chronic fatigue syndrome, or ME. Shock, overwork, excessive emotional strain, etc. causes the nadis to "crash", and thus energy does not reach the nervous system and you have a kind of nervous collapse. This may be why, for example, Kali Phos, a so-called nerve remedy, may be indicated in such cases.

**9.** The Logoic plane is the plane of God (or however we try to understand this concept). We do not have a Logoic body, although the Monad (or Spirit) is a "chip off the old

block", so to speak.

**10.** Perhaps this friction is what we could consider, from a philosophical point of view, to be the root of *psora* as a general human phenomenon, i.e., the basic delusion of existence, which has been written about in most of the great spiritual writings. Presumably an individual who has overcome his lower self would be free of *psora*, or "enlightened" as it is also called.

**11.** But not all. For instance, there is a class of diseases produced by conditions inherent in the structure of the planet itself—conditions such as geopathic stress. For example, see chapter 9 of *The Origin of Life* by Georges Lakhovsky (1935; later republished by BSRF), in which the author examines the statistical distribution of cancer in France against the underlying geology.

**12.** Which is to say, you don't have a separate chakra for each plane, but the planes are present in the chakras like layers in a sandwich.

**13.** Chronic diseases are defined in homoeopathy as non-self-limiting conditions which generally have a slow onset and an increasing degree of action (often spotted with acute episodes), ending in death. If it is correct that the miasms reside in the etheric body, should they be activated by a problem at an energy level higher on the scale (e.g., astral body impinged by shock) then it may be that you have to identify this and treat it, otherwise the maintaining cause, as it were, is still there.

**14.** See *Organon of the Medical Art* by Samuel Hahnemann (Wenda Brewster O'Reilly edition, 1996).

**15.** To indicate how broad this is, I would imagine that anyone who understood acupuncture and related concepts could use the appropriate Rae cards to perform a radionic diagnosis and treatment within the terms of traditional Chinese medicine. I do not know for sure, but I suspect that

the repertory until the best possible remedy match is found. Using radionic methods, which work via a certain human sensibility which has not yet been properly explained, we have the possibility of finding the name of the energy (remedy) by dowsing.

The problem with working from symptoms can be that the patient may not give you all of them, or may not remember certain things which happened, or may not consider certain things as being relevant or important enough to tell you, or perhaps the practitioner may misinterpret them. Consequently, you may never find the key to the case or you may give any number of what you think are well-selected remedies without useful results because you are missing a vital part of the picture.

Clearly, many successful homoeopathic prescriptions are made which bring about fantastic results, but just as clearly there are many failed prescriptions where cases are not resolved because a suitable remedy is not identified. Although some cases will indeed not be curable—for example, because of excessive medical drugging or gross pathology which has gone too far to be repaired—in general, these failures cannot be a failure of the principles

of homoeopathy because, given such circumstances, the "law of similars" could not be a law but a guideline. This is not good, because we deeply desire homoeopathy to be, and to be shown to be, successful on its own terms, e.g., through the law of similars, and not reliant on any alien methodology for an assessment of its viability.<sup>17</sup>

Therefore, the radionic diagnosis of the subtle energies, and selection of the remedy and potency by dowsing, can help us resolve the matter, particularly when the remedy cannot be discerned from the patient's stated symptoms. Whichever method is used to find the most similar remedy, however, is secondary to the fact that the therapeutic result does not abrogate Hahnemann's fundamental law, and thus, when applied in this way, the radionic method supports homoeopathic practice.

There is a further test which is possible with radionic techniques,

**Thus it could be that the remedy is the energised form field of the substance it represents ... or, to put it another way, the remedy is the energised archetype of the substance.**

which is that the effect of the selected remedy can be checked before it is administered to the patient. Abrams discovered that "a sample of quinine gave exactly the same reactions on the subject as malaria"; if he tested the blood of a malarial patient with a few grains of quinine, he could obtain no reaction at all.<sup>18</sup> There are various easy ways in which this test can be done with radionics instruments, and using the analysis in tandem with the remedy you can check against all detected problems to see how much action the remedy is likely to have. To put it another way, a hair sample provides a link with the energy field of the patient; when you

introduce the radionic rate or ratio card or sample of the remedy itself into that field, you are mixing the two together in some way. I presume that the remedy cancels out some distortion in the patient's field and thus rectifies it, and this is later reflected in the removal of the symptoms.<sup>19</sup>

#### **NEW CHALLENGES FOR HOMOEOPATHY**

As I have stated, analysis and treatment in radionics are often performed when the patient is elsewhere, possibly even on the other

side of the planet. Although I found these ideas fantastical at first, practical application has shown that diagnosing and treating at a distance does work. You can give someone a remedy by setting up the instrument appropriately, and they will receive it as if they had taken it by mouth. I have even had patients call me up and ask if I'd switched the machine on at such-and-such a time (which of course I had done) without first telling them. I can see that this will be a very disturbing idea to some readers, but I would like to look at it from another angle.

Since its beginnings, homoeopathy has been attacked by the medical establishment and even now is not really accepted in many quarters. It should also be noted that remedy manufacture is a very small industry when compared with the turnover of the major drug companies and is therefore no real threat to share prices and can be ignored. This sword, however, cuts two ways:

homoeopathic remedies which corrected any problems identified in Chinese terminology could also be dowsed out.

**16.** In a footnote in §6 of *The Organon*, Hahnemann states: "The medical-art practitioner can never see the...life force that creates disease, and he never needs to see it." In fact, the dynamis is something which is only detectable in terms of the symptoms it produces. Other lines of thought, such as that employed by radionics, suggest this is not so. There are grounds to believe that, in time, we will be able to see the dynamis and the subtle bodies. Drown and De La Warr developed radionic cameras which purported to be able to photograph the etheric fields of whatever the camera was tuned into, and this includes homoeopathic remedies; for instance, see De La Warr's radionic photograph of *Aconitum napellus* in *New Worlds Beyond The Atom* by George De La Warr and Langston Day (EP Publishing Ltd, 1956, now out of print).

There are also various so-called aura cameras around which appear to depict the aura quite accurately, although whether they show the other subtle bodies is not clear to me yet. I can imagine that interesting experiments could be done where people are photographed before and after taking a remedy, and so forth.

**17.** Such as the type of drug testing carried out by pharmaceutical companies. Except in the case of acute miasms, homoeopathy seeks to individualise its prescriptions and does not seek medicines for named diseases, as in "What've you got for ulcers?". The problem with pharmaceutical drugs is that most of the information on drug action is thrown into a big dustbin called "Side Effects", so that your ulcers are cured but you end up with high blood pressure, or whatever, and this is treated as a sort of unfortunate problem rather than an undesirable consequence. All this was clearly recognised by Hahnemann when

he described the biphasic action of drugs. The best way to advance homoeopathy is through success with patients, and not through attempting to struggle with mainstream science, because by and large the mechanistic mindset has not yet caught up to what homoeopathy is. On the other hand, if we homoeopathically treat a person who has symptoms which involve laboratory-identifiable micro-organisms and we claim to have cured the problem, I don't think it unreasonable for a lab test to be administered which establishes the presence or absence of the organism post-treatment.

**18.** Quoted from *Report on Radionics*, p. 28. I think most readers will recognise that this is where Hahnemann started out.

**19.** In electronic terms, this appears to me to be akin to the phenomenon known as "phase cancellation". If two identical waveforms in inverse relationship are added together, they will cancel each other out. I do not yet know

one way is that homoeopathy is not validated by mainstream science and therefore lacks a certain cachet, but the other is that to a considerable degree it is left alone, at least in the UK.

From reading *The Homoeopath* (issue 72), I know that Rolland Conte has made this claim: "There is now known to be a detectable difference between potentised and unpotentised material, and that difference has been confirmed by independently replicated scientific research."<sup>20</sup> While on the one hand this could be seen as good news and a validation of homoeopathy, it is actually only a validation of potentisation and not the law of similars, and is in a way (even though the science as described by Elwyn Rees is very esoteric) an attempt to rematerialise homoeopathy and treat potentised substances just like other drugs—which you will see if you visit Rolland Conte's website.<sup>21</sup> In short, it seems that Conte wants to treat remedies as if they were regular drugs and apply them to named diseases on a drug-per-disease basis.

If Conte is correct and can demonstrate a statistically significant success rate using a simple biomechanistic relationship between the remedy and the illness,<sup>22</sup> the present situation of homoeopathy could change quite radically, and I think it is necessary to consider the situation from a number of angles in case the classical position needs to be defended.

Contrary to Conte's claims, I would contend that homoeopathy is not a material science, even though it produces effects and results on the material plane. Using radionic techniques, we can demonstrate not only that remedies can be simulated, i.e., artificially manufactured, but also that they do not need to be manufactured at all in order to be administered to a patient; i.e., they can be administered by radionic broadcasting.<sup>23</sup> To me, this is something which is quite different from what is considered normal by mainstream science, and is *prima facie* evidence of why we must treat attempts to normalise homoeopathy along these lines with the utmost caution.

From Alice Bailey's viewpoint, physical reality is the result of the precipitation of energy into form via force—force being the

vector or idea, as it were, which organises energy. Thus the immaterial is first and the material comes afterwards. When Hahnemann invented higher-potency remedies, it's possible that he abstracted the energy and the vector from the physical substance. Thus it could be that the remedy is the energised form field of the substance it represents, the degree of potentisation being the amount of energy available; or, to put it another way, the remedy is the energised archetype of the substance.<sup>24</sup> That archetype provides something which will correct the "mistuned" energy field of the sick person and produce a cure.

All of this leads me to think that Hahnemann, apart from having provided us with a superb healing system, gave us one of the few actual proofs we have at present of the existence of supra-physical dimensions, and that the methods used in radionics and dowsing can be used to validate this view of Hahnemann's work (and solve prescribing problems). I personally consider the need to show the existence of higher orders of reality as important, since the alternative is that the mechanistic, materialistic model of science will continue to hold its dominant position,

with all the problems it has created for humanity and the planet.

In closing, I would like to reproduce part of a quote from a lecture by the late Aubrey Westlake, given to the British Society of Dowsers at Malvern in 1972:

*God hath chosen the foolish things of this world to confound the wise, and God hath chosen the weak things of the world to confound the things that are mighty... God hath chosen...things which are not, to bring to naught things that are... In the eyes of the world, radiesthesia is a thing of no account compared with, say, nuclear or astrophysics or atomic research, and yet...it can, when properly understood, open to us the mysteries both in this world and the world invisible. It can reveal to us the Truth in so far as our finite minds can comprehend it.*<sup>25</sup>

I would contend that homoeopathy is not a material science, even though it produces effects and results on the material plane.

if this idea throws any light on what actually happens in homoeopathy.

**20.** Quoted in the article "Conte and Context", by Elwyn Rees, published in *The Homoeopath*, issue 73, spring 1999 (The Society of Homoeopaths, 2 Artizan Road, Northampton, NN1 4HU, United Kingdom, tel +44 (0)1604 621400, e-mail societyofhomoeopaths@btinternet.com).

**21.** Medicine Quantale, the company formed to put Conte's ideas into practice, is at www.mql.com. Read through the website. Here are a few quotes:

"Although homoeopathic medicine does not constitute the entire scope and vision of MQL, the initial direction and efforts of the company are focussed on the industrialisation of this field of science."

"At present, world pharmaceutical consumption is valued at approximately US\$400 billion per annum, with only 1% currently related to the use of non-molecular or low-

concentration-molecule remedies, mainly used in 'homoeopathic' applications.

However, in view of the current interest in 'alternative medicine', the prescription of homoeopathic medicine is growing at a rate of around 20% per annum in the United States of America."

"In July 1997, MQL...entered into a research and co-operation agreement to conduct a study on the effects of high-level dilutions on the growth and behaviour of undifferentiated neuroectodermal primary tumours (medulloblastoma)...to assess the effects of certain prepared dilutions on cell growth..."

Conte's methods may of course prove to be correct, even though they appear to be against the spirit and the letter of classical homoeopathy. But if so, watch out. It is not inconceivable that you may end up paying royalties and licensing fees to Conte if appropriate patents are granted. You only have to look at the (successful) efforts of medical companies to

patent certain human gene structures to realise that this could be so.

**22.** Even though we know from the historical example of Richard Hughes (1836–1902) that this approach was not generally successful, apparently the biggest-selling 'flu remedy in France is Oscilloccinum 200C—one of the few remedies (maybe the only remedy) allowed in high potency by law in France!

**23.** I personally use pharmacy-manufactured, simulated and radionically broadcast remedies as seems appropriate. I am definitely not suggesting practitioners should give up on the pharmacies; we should use what we are comfortable with. On the other hand, I'd be very interested to run some radionically simulated remedies through Conte's testing process to see if there is a detectable change in the material. If the remedy works but there is no detectable change in the water, then what? If there is a detectable change, but it is produced

Continued on page 84





### JOHN BEDINI'S FREE-ENERGY MOTOR

**I**nventor John Bedini's free-energy motor has been around for over 15 years, but it is only recently that his research has received some much deserved attention.

On 26 April this year, electromagnetics researcher/consultant Lt Col. Thomas Bearden (Ret.) released an article, "Explanation of John Bedini's Formation of Negative Resistors in Batteries", which is available on the Sightings website, [www.sightings.com/general/resistors.htm](http://www.sightings.com/general/resistors.htm). It's preceded by John Bedini's letter of 27 April to Sightings radio talk show host Jeff Rense. Bedini explains why Bearden wrote the paper:

"It's because I helped a little 10-year-old girl to win every science award in Coeur

d'Alene...all first places plus a special award in science with one of my motors.

"The motor ran for four days, without stopping, at 4000 rpm. It also ran a generator producing power the entire time.

"The science teachers went nuts over this demonstration, and wanted to know how it worked.

"I then put the plans for it out on KeelyNet and gave the thing away freely. So far, the comments are good; some have already produced the free energy and have the motor running—but then there are always the others who say it can't work. (You can't win them all.)..."

Following is a 1996 article by John Bedini. It and the accompanying diagrams can also be seen at his website, [www.nidlink.com/~john1/foreward.html](http://www.nidlink.com/~john1/foreward.html), or at the KeelyNet website, [www.keelynet.com](http://www.keelynet.com).

**I**magine having a small DC electrical motor sitting on your laboratory bench, powered by a common 12-volt battery. Imagine starting with a fully charged battery and connecting it to the motor with no other power input. Obviously, the motor is going to run off the battery, but by conventional thinking it will stop when the battery runs down. Impossible, you say. Not at all. That's precisely what I have done, and the motor is running now in my workshop.

It isn't running by the conventional wisdom of electrical physics. It isn't running by the conventional rules of electric motors and generators, but it is running. It isn't something complex. It is pretty simple, once one gets the hang of the basic idea.

It is running off the principles of electromagnetics that Nikola Tesla discovered shortly before 1900 in his Colorado Springs experiments. It is running off the

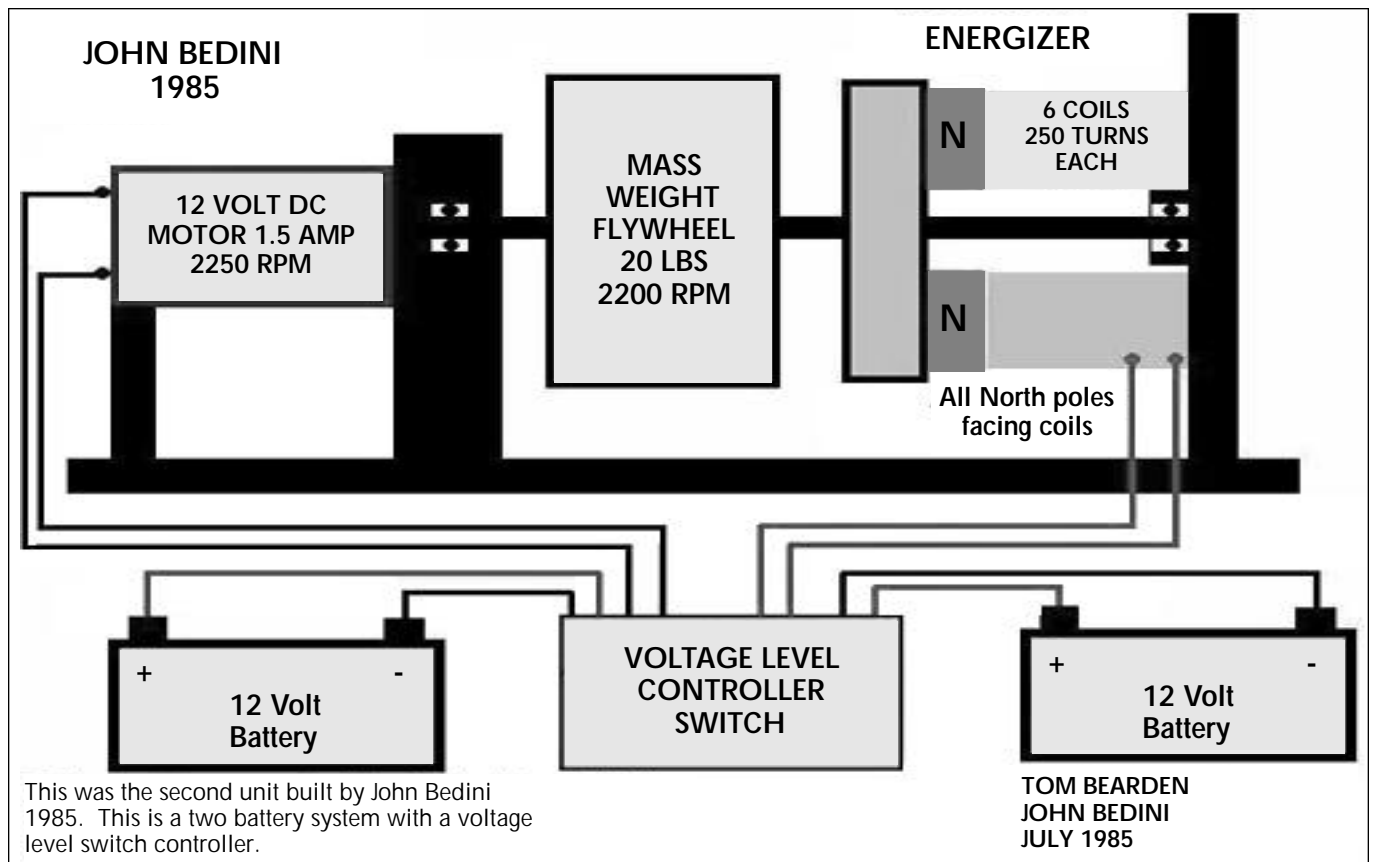

# NEWSCIENCE NEWSCIENCE NEWSCIENCE

fact that empty vacuum—pure "emptiness", so to speak—is filled with rivers and oceans of seething energy, just as Nikola Tesla pointed out.

It is running off the fact that vacuum space-time itself is nothing but pure, massless charge. That is, vacuum has a very high electrostatic scalar potential; it is greatly stressed. To usefully tap the enormous locked-in energy of that stress, all one has to do is crack it sharply and tap the vacuum oscillations that result. The best way to do that is to hit something resonant that is embedded in the vacuum, then tap the resonant stress of the ringing of the vacuum itself.

In other words, we can ring something at its resonant frequency and, if that something is embedded in the vacuum, we can tap off the resonance in vacuum stress, without tapping energy directly from the embedded system we rang into oscillation. So what we really need is something that is deeply embedded in the vacuum; that is, something that can translate "vacuum" movement to "mass" movement.

Well, all charged particles and ions are already embedded in the vacuum by their charged fluxes, so stressed oscillations—that is, vacuum oscillations—can be

converted into normal energy of mass movement by charged particles or ions, if the system of charged particles or ions is made to resonate in phase with our tapping "potential". For our purpose, let's use a system of ions.

**It is running off the fact that vacuum space-time itself is nothing but pure, massless charge.**

First, we will need a big accumulator to hold a lot of the charged ions in the system that we wish to shock into oscillation. We need something that has a big capacitance and also contains a lot of ions. An ordinary battery filled with electrolyte fits the bill nicely.

While it is not commonly known, ordinary lead-acid storage batteries have a resonant ionic frequency usually in the range of

from 1 to 6 MHz. All we have to do is shock-oscillate the ions in the electrolyte at their resonant frequency and time our "trigger" potential and "siphon" current correctly. Then if we keep adding potential to trigger the system, we can get all that "potential" to translate into "free electrical energy".

Look at it this way. Conventionally, "electrostatic scalar potential" is composed of work or energy per column of charged particle mass. So if we add potential alone, without the mass flow, to a system of oscillating charged particles, we add "physical energy" in the entire charged particle system. In other words, the "potential" we add is converted directly into "ordinary energy" by the embedded ions in the system. If we are clever, we don't have to furnish any pushing energy to move pure potential around. (For proof that this is possible, see Tom Bearden's "Toward a New Electromagnetics; Part IV: Vectors and Mechanisms Clarified", Tesla Book Co., 1983, Slide 19, p. 43, and the accompanying write-up, pp. 10–11. Also see Y. Aharonov and V. Bohm's "Significance of Electromagnetic Potentials in the Quantum Theory" in *Physical Review*, second series, vol. 115, no. 3, August 1, 1959, pp.

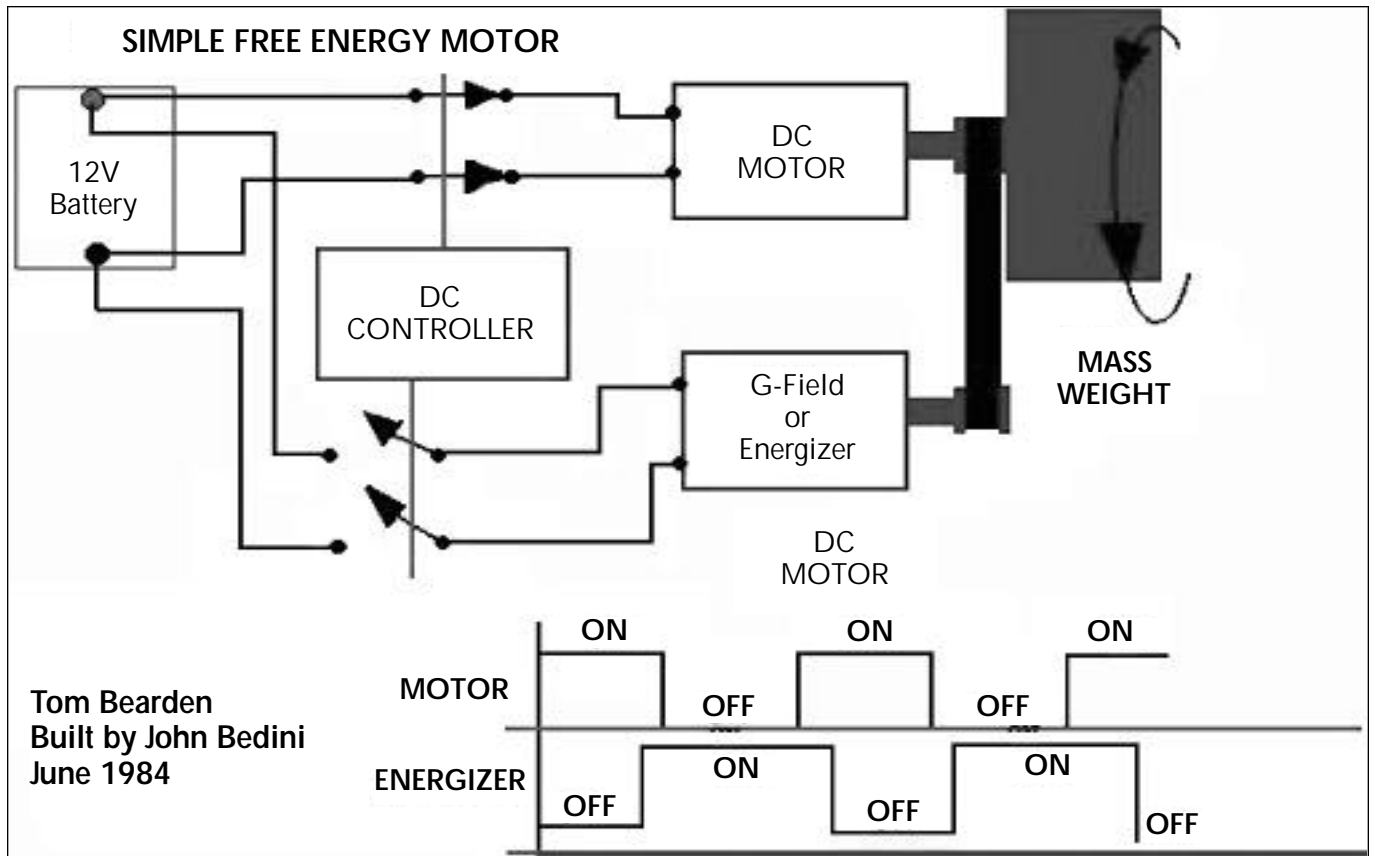

# NEWSCIENCE NEWSCIENCE NEWSCIENCE

485–491; on page 490 you will find that it's possible to have a field-free region of space and still have the potential determine the physical properties of the system.)

Now this "free energy resonant coupling" can be done in a simple, cheap system. You don't need big cyclotrons and huge laboratories to do it; you can do it with ordinary DC motors, batteries, controllers and trigger circuits.

And that's exactly what I have done. It's real. It works. It is running now on my laboratory bench in prototype form.

But that's not all. I am also a humanitarian. I am concerned for that little old widow lady at the end of the lane, stretching her meagre Social Security check as far as she can, shivering in the cold winter and not daring to turn up her furnace because she can't afford the frightful utility bills. That's simply got to change, and I may well be the fellow who changes it. By openly releasing my work in this paper, I am providing enough information for all the tinkers and independent inventors around the world to have a go at it. If I can get a thousand of them to duplicate my device, it simply can't be suppressed as so many others have been.

So here it is. I have deliberately written my paper for the tinkerer and experimenter, not for the scientist. You must be careful, for the device is a little tricky to adjust-in and synchronise all the resonances. You'll have to fiddle with it, but it will work. Keep at it.

Also, we warn you not to play with this unless you know what you are doing. The resonating battery electrolyte produces hydrogen, and if you hit it too hard with a "voltage spike" you can get an electrical spark inside the battery. If that happens, the battery will explode, so don't mess with it unless you are quali-

fied and use the utmost caution.

But it does work. So all you experimenters and pioneers, now's your chance. Have at go at it. Build it. Tinker with it. Fiddle it into resonant operation. Then let's build this thing in quantity, sell it widely and get those home utilities down to where we can all afford them—including the shivering little old lady at the end of the lane.

And when we do, let's give men like me the credit and appreciation they so richly deserve.

— John C. Bedini © 1996

*The following comment, from an unnamed representative of the US Institute of Electrical and Electronics Engineers, Inc., can also be seen at John Bedini's website.*

John C. Bedini has constructed a laboratory model of a machine in which output energy exceeds input. It consists of a lead-acid battery which powers a small DC

motor, which turns a magneto-like dynamo, which provides output energy to an electronics package, which in turn feeds timed (scalar?) pulses back to the battery terminals for recharging.

As a demonstration, Bedini then removes the good battery and sequentially inserts fully discharged, dead batteries. Each of the dead batteries eventually receives a full charge. Stated differently, he starts with one good battery and four discharged batteries. At the end of the demonstration, all five batteries are fully charged.

This author has personally visited Bedini's lab many times, in company with technicians and professors of physics and electrical engineering. None of us has been able to fault Bedini's findings.

Each of my professorial friends, however, has requested that their names not be used for attribution, the inference being that their respective universities would not be understanding of heretical concepts.

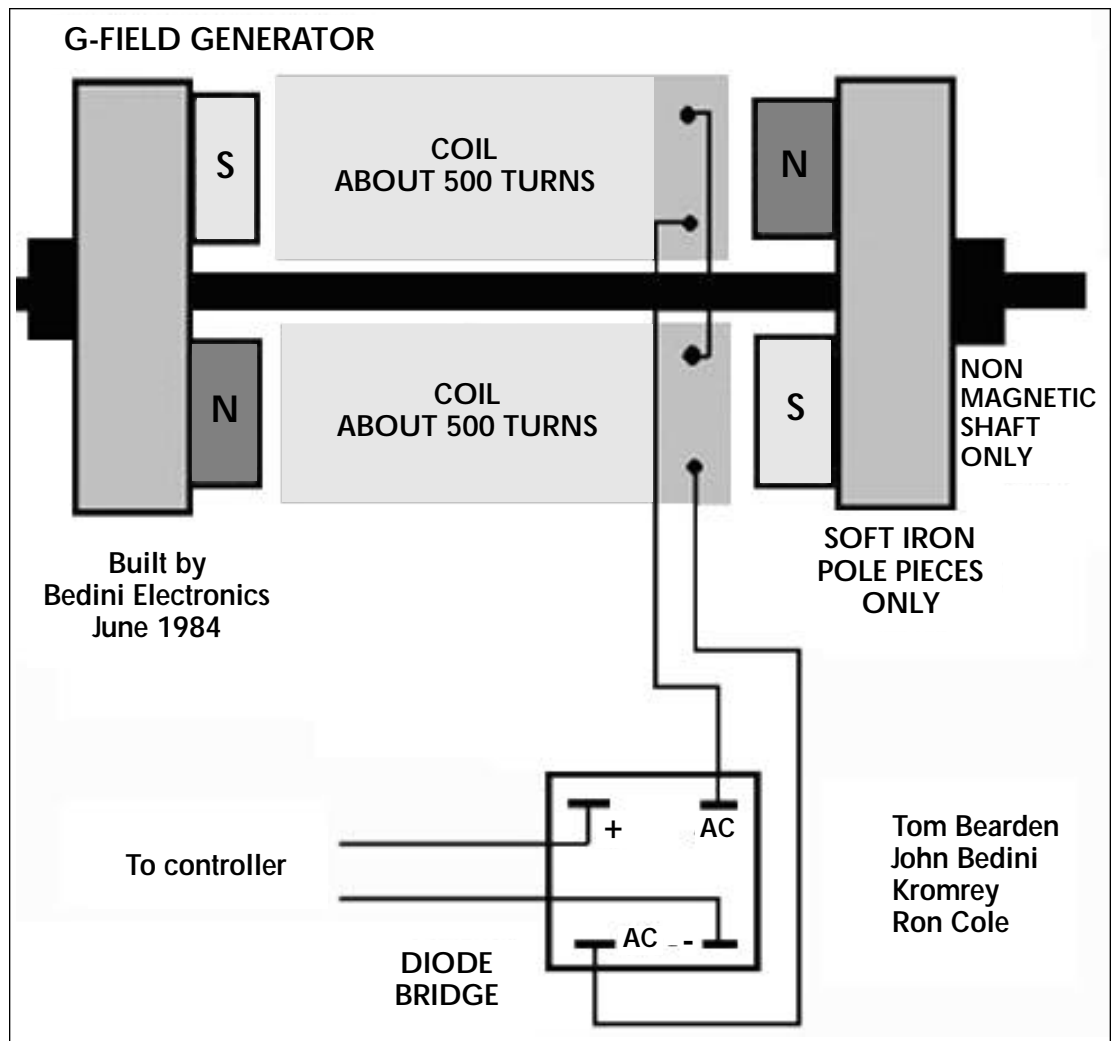



# THE CIA, UFOs, MJ-12, JFK & JAMES JESUS ANGLETON

*As the CIA's  
Counterintelligence  
Chief, James Jesus  
Angleton had  
access to the  
Agency's most  
closely guarded  
secrets, including  
MJ-12 files on  
UFOs.*

by Timothy S. Cooper © 2000

PO Box 1206  
Big Bear Lake, CA 92315  
USA  
Telephone: +1 (909) 878 5929

James Jesus Angleton was born on December 9, 1917 in Boise, Idaho, to NCR businessman/OSS Colonel James Hugh Angleton and Mexican-born Carmen Mercedes Moreno. Upon graduation from Yale in 1941, Angleton moved to Harvard Law School where he met his future wife, Cicely d'Autremont, of Duluth, Minnesota. Inducted into the US Army on March 19, 1943, Angleton was recruited into the Office of Strategic Services (OSS) in August through the efforts of Angleton's father and Norman Pearson, his old English professor from Yale who at that time was head of the OSS Counterintelligence division in London.<sup>1</sup>

## OSS COUNTERINTELLIGENCE OPERATIONS DURING WW II

James Jesus Angleton was assigned the Rome desk after Italy's capitulation to the Allies, and was made an OSS Lieutenant who ran counterintelligence (CI) activities in such countries as Austria, Germany, Spain and Switzerland as well as the Mediterranean area. As part of OSS operations in the European theatre, Angleton mastered the arts of "black" propaganda and "playback"—that is, the method of reading the effectiveness of one's own disinformation on the enemy. In 1944, he was given charge of the OSS Special Counterintelligence Unit Z, made up of US and British agents, and was the youngest member of X-2 and the only American member allowed access to the top-secret British ULTRA code-breaking intelligence.

After the war, Angleton was promoted to Captain and was awarded the Legion of Merit from the US Army which cited him for successfully apprehending over a thousand enemy intelligence agents. He was also decorated by the Italian Government and was awarded the Order of the Crown of Italy, the Order of Malta/Cross of Malta and the Italian War Cross for Merit.

In October 1945, President Truman dissolved the OSS and had all research and analysis units moved to the State Department and operational units to the War Department, and redesignated it as the Strategic Services Unit (SSU). Angleton stayed on in the SSU in Rome and became the vital station chief in charge of the 2677 Regiment, which made Angleton the senior US intelligence officer in Italy until the SSU became the Central Intelligence Group (CIG) in 1946, forerunner of the Central Intelligence Agency (CIA).<sup>2</sup>

## THE MAKING OF JAMES ANGLETON AS A MASTER SPY HUNTER

Angleton's war experience in counterintelligence operations had affected him to the extent that he became absorbed into the "hall of mirrors" world of intelligence and refused to leave the service, despite much insistence and disappointment from his father. James would pour over the many CI files he had amassed while in Italy and was forever changed by the intrigue and the possibilities of a career in the CIG.

In the summer of 1947, Angleton returned to the United States to live in Tucson, Arizona, to be with his wife and family, but his love for the service was overpowering. On December 30, 1947, he was hired by the CIA as a senior aide to the Director of the Office of Special Operations (OSO).<sup>3</sup> It was during this period that Army G-2 and other intelligence agencies were trying to crack the Soviet *Venona* code, used by espionage agents operating in the United States to send back sensitive information regarding the Manhattan Project based at Los Alamos, New Mexico. It is possible that Angleton was on special assignment prior to officially reporting to the OSO, which had the responsibility of running counterespionage operations.<sup>4</sup> Angleton's primary mission in the OSO included overseeing a classified component that operated espionage and counterespionage activities abroad, and reading all sensitive material coming across his desk and passing it to OSO operators

in countries where the CIA had interests. In 1949, he moved up the chain of command within the OSO and held a GS-15 position.

Angleton developed the philosophy, "If you control counterintelligence, you control the intelligence service". He quickly realised the significance of the B-29 detection of Joe-1, the Soviet's first atomic weapon detonation in August 1949, and knew that the technology acquired by the Soviets was not home-grown but the product of espionage. He immediately set out to discover who the moles were who passed on America's most guarded secret to Moscow. As with all covert actions, counterintelligence operated without specific mention in the National Security Act of 1947, so Angleton set out to acquire information on the most guarded secret of all.

### ANGLETON AS CHIEF OF COUNTERINTELLIGENCE

Aside from the theft of atomic secrets, the most guarded secret within the CIA was the scientific and technical information regarding new weapons developments, including the planned use of a new generation of thermonuclear weapons and high-altitude reconnaissance platforms for spying on countries hostile to US strategic interests. One of the technical secrets was the study and transfer of advanced electronics gleaned from US Air Force studies of unconventional aircraft and missile research carried on at several Atomic Energy Commission facilities and proving grounds.

The FBI and the CIA were aware of Soviet espionage rings operating in the United States, Canada and the United Kingdom. The main task of these rings was to provide any and all technical and scientific information on advanced technologies which would give an advantage to the Soviet Union in the event of another world war breaking out.

By 1949, military intelligence authorities had classified the "flying saucer" phenomenon as Top Secret, and the Army Counter Intelligence Corps (CIC) had passed on information that the Soviets could have developed saucer-shaped aerial weapons, capable of delivering atomic bombs or dissipating radioactive materials over NATO countries, as a stopgap measure to make up

for the nonexistent nuclear weapons arsenal. In early 1947, the nonexistent nuclear arsenal in the United States was a closely guarded secret as well; and no doubt this fact set in motion the nuclear arms race, which terrified Angleton. The OSO was probably aware of Soviet knowledge of the bomb gap existing within both superpowers. Moreover, the flying saucer invasion of the United States—reports of which crossed Angleton's desk—put a scare into Angleton's psyche which is reflected in a credo he shared with other OSO staff members: "You who believe or half believe, I can say this now, that I do believe in the spirit of Christ and the life everlasting, and in this turbulent social system which struggles sometimes blindly to preserve the right to freedom and expression of spirit. In the name of Jesus Christ, I leave you."

After General Walter B. Smith was appointed Director, Central Intelligence (DCI), Angleton continued on with OSO Staff A (foreign intelligence operations) inside the CIA's clandestine division.

In 1951, he was assigned the all-important Israeli desk, which he held under tight control for 20 years because it was a vital source of Soviet information in the Middle East. As more and more UFO<sup>5</sup> sighting reports made their way to CIA headquarters, unevaluated reports were forwarded to Counterintelligence when the locations were identified as coming from Soviet Bloc countries. During this period, Angleton established good links with FBI contacts who were equally concerned with protecting vital atomic research facilities, and no doubt he read many domestic reports as they came across his desk in the "L" Building across from the Lincoln Memorial.

When Smith was coaxed away from his power base as DCI, Allen Dulles—Angleton's friend from OSS days—became the new Director. In late 1954, he promoted Angleton to the position of Deputy Director and Chief of Counterintelligence, with direct access to Dulles and all foreign UFO intelligence from the Intelligence Advisory Committee (IAC) which had been established to look into national security implications involving the

UFO phenomenon.<sup>6</sup> In order to cement Angleton's counterintelligence charter, Dulles commissioned General James H. Doolittle to conduct an outside survey of CIA counterintelligence operations. Doolittle concluded that the CIA was losing ground to the KGB, and recommended that more stringent and ruthless measures be taken against Soviet penetration. Dulles endorsed the Doolittle Report by ordering a more powerful tool to stop and interdict the moles within the CIA, and he personally chose Angleton to head the CI Staff. Perhaps this is why foreign and domestic UFO sighting reports diminished in number shortly afterwards.

During Dulles's tenure as DCI from 1953 to 1961 (the longest in CIA history), Angleton enjoyed a privileged position not shared by other directors. This was despite the fact that Angleton reported to the Deputy Director of Operations (DDO), and on many occasions bugged the phones and residences of various high-ranking US Government officials and foreign dignitaries with Dulles's approval and over the objection of the DDO. If the situation called for it, Angleton could

go around proper channels to acquire personal data on anyone within the CIA and other agencies, which was clearly outside the CIA charter and violated FBI jurisdiction.

As the new head of CI, Angleton had to organise a staff, write the rules and oversee all clandestine operations aimed at the Soviet Intelligence Service military and security organs, the GRU and KGB.<sup>7</sup> The CI Staff was primarily tasked with preventing penetrations at home and abroad and protecting CIA operations through careful research and analysis of all incoming intelligence reports. By keeping the most vital and sensitive files to himself, Angleton became a storehouse of secrets, which helped him consolidate his power base. Officially, Angleton was allowed access to everyone's personnel, operational and communications files within the CIA, and he reviewed all proposed and active operations and approved the recruitment of agent assets. This did not engender trust or cooperation, but Angleton did not concern

**As more and more UFO sighting reports made their way to CIA headquarters, unevaluated reports were forwarded to Counterintelligence when the locations were identified as coming from Soviet Bloc countries.**

himself or his staff with such intrusions. One of Angleton's former Chief of Operations, "Scotty" Miller, described the environment in which CI Staff operated as that of a "watchdog" snooping around, sniffing out Soviet deception and manipulation.

### ANGLETON AND THE MJ-12 DIRECTIVE

Among the controversial documents leaked to the public in the last 20 years regarding state secrets and the UFO phenomenon, are the CIA's unacknowledged Majestic Twelve/MJ-12 files which disclose the most guarded of all classified subjects: extraterrestrial life-forms and their technologies.<sup>8</sup>

In order to secure this knowledge and prevent foreign countries from learning this vital secret and getting an edge on the United States, President Harry S. Truman signed a directive that basically said that no one (including a chief executive) was to be in possession of or disclose the finding without a "need to know" clearance which was above Top Secret.<sup>9</sup>

The directive was secretly implemented without the knowledge or consent of Congress and was concealed by the wording of the National Security Act of 1947, which prohibits the disclosure of classified matters without presidential approval and prior agreement by the Department of Defense and the Central Intelligence Agency, as amended in later versions of the National Security Act.

Knowledge of the finding was limited to only a select few within the government's intelligence and scientific communities. As long as the secret remained unresolved, there would be no official acknowledgement. The only official study program, Project *Blue Book*, was taken over by the CIA in 1953 as a public experiment and used as a debunking tool to discount the extraterrestrial reality, and possibly to quash any attempts by the KGB and GRU to glean any technological or defence secrets from the study.

Like the Manhattan Project group, Majestic Twelve or MJ-12 (as used in some leaked documents) was a joint government/military/private-sector undertaking that encompassed every facet of national security functions. The CIA was the premier intelligence agency tasked with maintaining the first line of defence of the United States during the 55-year Cold War between the capitalist West and the communist East. When Angleton assumed his throne as Chief of Counterintelligence, no doubt Truman's directive was a most inviting instrument, allowing him to carry on his mole-hunting career within the CIA against the KGB and GRU.

Majestic Twelve enjoyed greater protection than did the hydrogen bomb program of the early 1950s. With that, the Soviets were driven to penetrate not only the secrets of the H-bomb program itself, but the ultimate prize that lay scattered throughout the US Government's maximum security research facilities located

in the southwestern and eastern United States.

The shocking truth of the Soviet atomic weapons espionage program, *Enormous*, dealt a tremendous blow to US and British security when it was learned that British diplomats operating within the US State Department, as well as US Army technicians at Los Alamos National Laboratories, had not only supplied blueprints and materials for the atomic bomb to their KGB handlers in New York, but had stolen the proposed plans for the hydrogen bomb as well. Security officials were left guessing as to what else the Soviet spies had stolen from under their noses.<sup>10</sup>

As far as we know, there was no successful penetration by KGB or GRU agents into the CIA's UFO program—in large part, due to the disgraceful and unlawful actions taken by Angleton's CI Staff. After the fallout from the Burgess-MacLean-Philby defections and the execution of the Rosenbergs, Angleton tightened security and dedicated himself to safeguarding whatever secrets still eluded the Soviets. Thus he embarked on a vicious mole-hunt that would almost paralyse the CIA until his departure in 1974.

During the time of the Eisenhower administration (1953–1960), the CIA was at its apex in covert operations, piling up one success after another where cores of Soviet moles were detected and sent home to Moscow. However, comments from the White House were nil when it came to the UFO problem, although Eisenhower's supposed meeting with extraterrestrials in 1954 was given some publicity. While it was largely discounted by the Press, some did try to connect Eisenhower's heart attack with the meeting. The national media were downplaying the UFO sightings in the US and abroad as part of a Cold War hysteria that accompanied the "duck and cover" scare that seemed to grip the country. No real problems popped up until the 1960 presidential elections when Democratic candidate Senator John F. Kennedy accused the Republican incumbent President Eisenhower of allowing a "missile gap" to exist, and charged that the United States was getting too close to the Soviet Union through *détente*.

The only official study program, Project *Blue Book*, was taken over by the CIA in 1953 as a public experiment and used as a debunking tool to discount the extraterrestrial reality ...

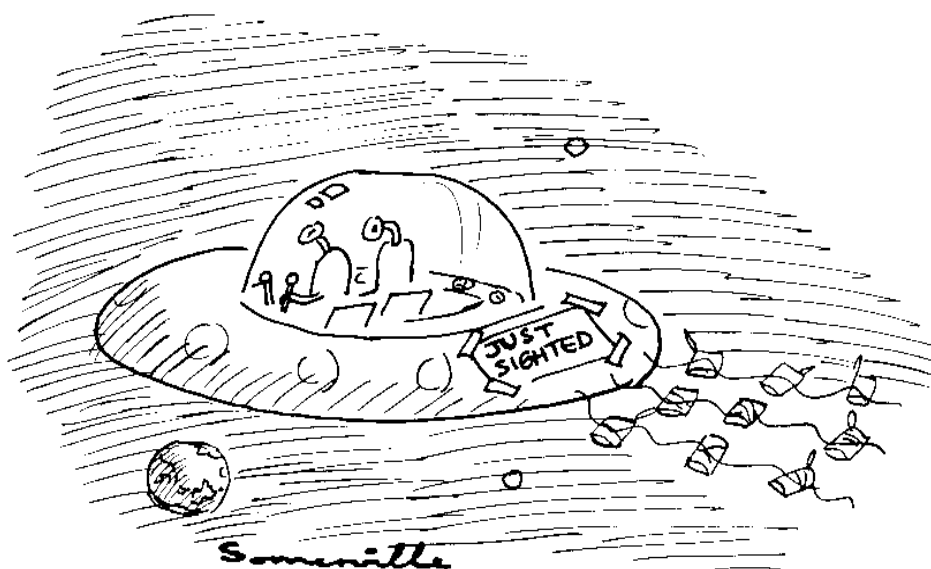

Soon after Kennedy became President, he began to needle the CIA for information on UFOs,<sup>11</sup> which was unnerving at the outset to Allen Dulles after he was burned over the failed Bay of Pigs invasion of Castro's communist-enslaved Cuba in April 1961. The once cordial relationship that had existed fell apart, and Dulles knew his time as DCI was short—as evidenced in his 1961 draft directive to MJ-12.<sup>12</sup> He knew that the explicit instructions contained in the September 24, 1947 Truman directive—prohibiting the DCI from making disclosures to a chief executive who obviously did not have a "need to know" clearance—would compromise the CIA, but also that the lengthy and costly UFO program, deemed so necessary to national security by all involved, simply could not be jeopardised for anyone—not even the President of the United States.

Knowing the character of Allen Dulles and James Angleton, I can only speculate as to what kind of response Kennedy got. The DCI Top Secret/MJ-12 document leaves no doubt that Dulles was not going to cooperate with Kennedy's request of June 28, 1961, which he forwarded to Angleton for consideration and feedback.

Majestic Twelve/MJ-12 included spin-off projects that were obviously equally sensitive activities of the CIA, such as *Parasite*, *Parhelion*, *Enviro*, *Psyop*, *Green*, *Spike* and *House Cleaning*. Other sensitive and covert programs could be affected as well, such as *MK-ULTRA*, *Artichoke* and *Domestic*, which all appear to have been operational projects associated with Majestic Twelve. The full implications of the above are not clear at present, but it is obvious that the other projects were held in readiness for some kind of mass indoctrination and deception undertaking in a national crisis.

#### MARILYN MONROE AND MURDER, INC.

The pressure put on the CIA by Kennedy was reaching a flash-point of wills; and with the Noresenko affair<sup>13</sup> driving Angleton to

obsession, a UFO leak crisis brought new strains on Angleton. He learned that Hollywood screen star Marilyn Monroe's phone conversation with a New York art dealer<sup>14</sup>—in which she discussed Kennedy's secret visit to an undisclosed military base to see alien artifacts, and her disdain over her soured relationships with President Kennedy and his brother, the United States Attorney General—had been recorded by CIA domestic electronic surveillance experts. Since 1955, Monroe had been under surveillance by the CIA, and the FBI had maintained a security dossier on her because of her marriage to a well-known American writer suspected of having communist affiliations, and her trip to Russia and the Press coverage she received while she was there.<sup>15</sup>

The wire-tap report also mentions nationally recognised New York syndicated reporter Dorothy Kilgallen as having conversations with Monroe regarding the Roswell UFO crash of 1947 and President Kennedy's politically motivated NASA *Apollo* Moon program. Dorothy Kilgallen made headlines in 1955 when she disclosed a private conversation with a British Cabinet official who told her that UFOs are real and that the US and British authorities consider the matter as of the highest importance.

The significance of the wire-tap has to do with the fact that Monroe was murdered the following day in her Brentwood condo. According to Milo Speriglio, internationally recognised private investigator and director of the Nick Harris Detective Agency, Monroe was the victim of a national security management hit by the CIA and the Mob.<sup>16</sup> The suggestion that somehow the CIA was involved in a domestic murder of an American citizen is not too far-fetched when considering the past abuses coming from Angleton's CI program with its "absolute security at any cost" philosophy. Whether Angleton authorised the hit is not known, but the *modus operandi* of the way her body was found and moved around, the fashion in

**The suggestion that somehow the CIA was involved in a domestic murder of an American citizen is not too far-fetched when considering the past abuses coming from Angleton's CI program ...**

#### Endnotes

1. September 25, 1943 OSS memo, released through the FOIA in September 1989.
2. US Senate Select Committee to Study Government Operations with Respect to Intelligence Activities, Final Report, Book VI, April 23, 1976, pp. 154-55.
3. JJA personal records. Angleton took a seven-month leave of absence to remain in Tucson, Arizona, for unspecified reasons, not substantiated by the need to be with his wife and family—as is believed by other writers regarding Angleton's absence from CIA's Washington headquarters during May through December 1947. See Tom Mangold, *Cold Warrior James Jesus Angleton: the CIA's Master Spy Catcher*, Touchstone Books, Simon & Schuster, 1991, p. 361.
4. On December 12, 1947, the National Security Council (NSC) adopted measures to counter the espionage and

counterespionage threat, as specified in NSCID 1, later amended in NSCID 5, that authorised the Director of Central Intelligence to "conduct all organized Federal espionage and counterespionage operations". According to CIA historian Arthur B. Darling, atomic weapons research became an overriding issue, and coordination with the Office of Scientific Research and Development with the AEC was through CIA consultant Dr H.P. Robertson, through General Vandenberg's directive containing an agreement between Dr Vannevar Bush which facilitated the transfer of Manhattan Engineering District files to the Director of Central Intelligence for proper collection of foreign atomic energy research. Secret OSO activities in this area were not allowed to fall into administrative control of the AEC nor FBI, as Vandenberg thought they should remain within CIA intelligence operations. See Arthur B. Darling's *The*

*Central Intelligence Agency: An Instrument of Government to 1950*, Penn State Press, 1990, pp. 197-239.

5. The term "UFO", as defined by Air Force intelligence directives, is used here to reflect unconventional aircraft and missiles, not interplanetary spacecraft.
6. CIA FOIA response letter, dated March 26, 1976, to a July 14, 1975 FOIA request made by Ground Saucer Watch of Phoenix, Arizona, in which it stated that the NSC tasked the CIA with a requirement to determine the actual UFO threat. The CIA responded through the Office of Scientific Intelligence by creating the Intelligence Advisory Committee to study the threat aspects. Military members of the IAC fought vigorously to maintain participation in areas relating to AEC intelligence collection. The Joint Chiefs of Staff, represented by General Todd (who is mentioned in an FBI memo regarding Joint Staff Council ignorance of flying saucer

which the autopsy records were changed to reflect suicide, and the theft of her secret red diary one day after her autopsy, all have similarities to the methods used by Angleton's covert CIA Counterintelligence operators.

### JFK AND THE CIA'S UFO FILES

The final straw for Angleton came when President Kennedy fired off a Top Secret memorandum to him,<sup>17</sup> outlining a previous discussion concerning a classification review of all CIA UFO files that could affect national security. It was dated November 12, 1963—just 10 days before he would be gunned down in the streets of Dallas, Texas.

Kennedy informed Angleton that he was setting things in motion to share sensitive CIA UFO intelligence data with the Russians through the director of NASA, James Webb.<sup>18</sup> This request was made on the same day he requested Webb<sup>19</sup> to begin Kennedy's peace overture to the Russians via joint space exploration. Webb, being a board member of the intelligence community,<sup>19</sup> most likely interpreted Kennedy's program to mean the sharing of classified UFO data, which was forbidden under the current directive.

In Kennedy's Top Secret memorandum,<sup>20</sup> he outlined for Angleton the specific items he wished to have disclosed to Webb, such as "[to] have the high-threat cases reviewed with the purpose of identification of bona fide as opposed to the classified CIA and USAF sources", and "that we make a clear distinction between the known and unknowns in the event the Soviets try to mistake our extended cooperation as a cover for intelligence-gathering of their defense and space programs". Finally, Kennedy wanted Angleton to "arrange a program of data-sharing with

Here, Kennedy was requesting the Central Intelligence Agency—the agency he swore he would "break into a thousand pieces"—just to hand over the most guarded secret ever!

NASA mission directors in their defensive responsibilities".

This was unprecedented and was totally unacceptable to Angleton and the CIA. Here, Kennedy was requesting the Central Intelligence Agency—the agency he swore he would "break into a thousand pieces"—just to hand over the most guarded secret ever!

This memo was passed on to William Colby, who indicated to someone in Angleton's staff in a handwritten note, "Response from Colby: Angleton has MJ directive".<sup>21</sup> The note is dated November 20, 1963—just two days before Kennedy's assassination.

It seems that Kennedy's request was bounced to and from Angleton's desk; either consensus was being sought, or the buck was being passed back to Angleton. In any case, it was a hot potato that Angleton had to deal with. It is also significant that NSAM No. 271 was the last to come from Kennedy's desk, just before he left Washington for Dallas. Whatever the real significance, it was buried somewhere within the CIA, and Angleton spent many a day trying to figure out who ordered Kennedy's execution.

Was Angleton set up, or did he unintentionally supply the needed ingredient for the murder of the century? In either case, the secret remained safe.

### NSA SPECIAL ACTIVITIES

One of the few former CIA officers to speak publicly on the Kennedy assassination and the UFO secret is Victor Marchetti, who at one time was Assistant to the Deputy for Plans and Operations under DCI William Colby. In a rare interview with *Second Look* magazine in 1979, Marchetti—author of the sensational book, *Cult of Intelligence*, which was vetted and censored by the CIA prior to publication (the only book to include the redacted portions within the text)—made some interesting observations

data in 1947), were at odds with the CIA about duplication of efforts by the Military Intelligence Division in producing UFO intelligence data for the IAC. See Arthur B. Darling, *ibid.*, pp. 349-356.

7. The KGB, the Committee for State Security, was a non-military arm of the Soviet Intelligence Service. The GRU was the military arm. The KGB received its title in 1954. When mentioning the Russian Intelligence Service, KGB and GRU are referenced generically to include both organisations.

8. This remarkable fact is substantiated in the mistakenly downgraded Top Secret Canadian Department of Transport intra-departmental correspondence, dated 21 November 1950, from Wilbert B. Smith to Dr Robert I. Sarbacher, an American physicist and science consultant in the US Defense Department's Research and Development Board and a member of the Guidance and Control Panel. Smith acknowledged that UFO studies were

"considered by the United States authorities to be of tremendous significance" and that the "matter is the most classified subject in the United States Government, rating higher than the H-bomb".

9. September 24, 1947 Top Secret/MAJIC/Eyes Only Project *White Hot* Preliminary Estimate in Five Parts (unacknowledged by the US Government). See Robert M. Wood, PhD, and Ryan S. Wood, *The Majestic Documents*, Wood & Wood Enterprises, 1998, pp. 43-81.

10. November 25, 1955 Top Secret memorandum from Rear Admiral Edwin T. Layton, Deputy Director for Intelligence, The Joint Staff, to the Chairman, Joint Chiefs of Staff, ref. JCS 1712/5. This report deals with the Burgess-MacLean defection, after it was learned that sensitive weapons research information had been sent to Moscow through diplomatic means and after the CIA was informed of the defection. Angleton was devastated to

learn that Kim Philby, a longstanding friend of British intelligence, was part of the spy ring.

11. Unacknowledged June 28, 1961 Top Secret National Security Memorandum from President John F. Kennedy to The Director [Dulles], Central Intelligence Agency, Subject: Review of MJ-12 Intelligence Operations as they relate to Cold War Psychological Warfare Plans. It is a one-line request that reads: "I would like a brief summary from you at your earliest convenience."

12. Unacknowledged CIA Top Secret/MJ-12 Counterintelligence carbon copy of draft directive from Director of Central Intelligence to MJ-12 members 1 to 7, with eight tabs on government watermark onion skin paper, circa 1961.

13. Yuriy Ivanovich Norsenko was a Soviet KGB officer who defected in 1962. Angleton had him detained and tortured for three years, believing the warning given by another KGB defector, Anatoliy

regarding the CIA's UFO intelligence-gathering program and why the subject is not open for discussion.

Retired Air Force intelligence officer Robert Collins produced for his website an insightful foreword to an extract from the Marchetti interview, in which he quotes Marchetti as saying: "My theory is that we have, indeed, been contacted—perhaps even visited—by extraterrestrial beings, and that the US Government, in collusion with other national powers of the Earth, is determined to keep this information from the general public."

Marchetti alluded to "rumors" at the highest levels within the CIA that the NSA has information as well, and that this must be kept away from public viewing.

We know now that the National Security Agency *does* have sensitive COMINT files, which for reasons of national security it cannot disclose. One of these NSA files that Marchetti speaks of might be the NSA intercept of Kennedy's phone conversation with Khrushchev on November 12, 1963, in which Kennedy spoke of a "situation that affects both our countries and the world" and "a problem that we share in common".

It is believed that the UFO problem became a national security issue when President Truman authorised the covert establishment of the National Security Agency, whose primary responsibility bordered on "special activities"—perhaps as outlined in an alleged

Intelligence Estimate prepared by national security officials on September 30, 1947, in which one of the concerns stated that "what we are up against is controlled by intelligent operators" and that "these objects are real and not illusionary".

It is not surprising that, in 1968, an NSA employee drafted a significant analysis of the intelligence community's ambivalence towards the UFO camouflage and warned of dire consequences unless the defence establishment woke up and recognised the danger these phenomena pose in the nuclear age.

On a final note, the legend of James Jesus Angleton and his "wilderness of mirrors", as he often referred to his daunting task of protecting vital state secrets, faded into obscurity on May 11, 1987. But the secret that went with him re-emerged almost precisely the day he died.

Perhaps Jim was not the real bad guy in the counterintelligence game. Maybe he was its victim.

#### **About the Author:**

Timothy S. Cooper is an independent researcher and writer who has worked in security and

investigation fields for 15 years. A Vietnam veteran, he began researching military UFO intelligence operations in 1988 and has collected extensive CIA and NSA files. He has also acquired the largest collection of MJ-12 documents and privately owned, original Project *Blue Book* files in the USA.

**... the UFO problem became a national security issue when President Truman authorised the covert establishment of the National Security Agency, whose primary responsibility bordered on "special activities" ...**

#### **Endnotes (continued)**

Mikaylovich Golitsyn, that Norsenko was ordered to defect and act as a disinformation plant to spread misleading information to the CIA regarding Soviet capabilities and intentions. Later CIA analysis suggested that it was Golitsyn, not Norsenko, who was the real mole planted within the CIA. Angleton was convinced that Golitsyn was a bona fide defector and he used Golitsyn's information, but the CI mole-hunt virtually destroyed the CIA's covert operations for some time.

14. Top Secret CIA wire-tap report, dated August 3, 1962, of discussion between Marilyn Monroe and Howard Rothberg, with references to *Project 40*, *Moon Dust*, the 5412 Committee and MJ-12. The report was given to Angleton and has his signature at the bottom right-hand portion of the document, establishing that CI was aware of Monroe's desire to blackmail the Kennedys over their indiscretions during a sexual affair with her prior to August.

15. FBI file No. 105-40018-1, formerly classified Secret. CIA is copied on an August 19, 1955 FBI document from Mr Dennis A. Flinn, Director, Office of Security, Department of State. A copy was sent to Director, Central Intelligence Agency, for the attention of Deputy Director, Plans, and was marked Secret. It was declassified on November 11, 1978,

but the subject matter was redacted.

16. See Adela Gregory and Milo Speriglio, *Crypt 33: The Saga of Marilyn Monroe – The Final Word*, Birch Lane Press, 1993.

17. This would be amazing, since no one in government knew that James Angleton worked for the CIA, much less of his existence, since there were few pictures of Angleton and very few within the Agency knew who he was and what he did. It is also interesting that until his appearance before the Church Committee in 1975, the public did not know about Angleton or his CIA Counterintelligence position. His identity had been kept secret for 20 years.

18. National Security Action Memorandum No. 271, dated November 12, 1963, to The Administrator, National Aeronautics and Space Administration, Subject: Cooperation with the USSR on Outer Space Matters. President Kennedy instructs James Webb as Administrator of NASA to "...assume personally the initiative and central responsibility within the Government for the development of a program of substantive cooperation with the Soviet Union in the field of outer space, including the development of specific technical proposals. I assume that you will work closely with the Department of State and other agencies as appropriate." Kennedy had requested an

interim report on NASA's progress in this adventure by December 15, 1963. Of course, after Kennedy was killed, this program was never acted upon.

19. It should be pointed out here that James E. Webb served on President Truman's Psychological Warfare Strategy Board and assisted in revising NSC 10/2 for the Office of Policy Coordination (Covert Operations) in 1948 for the CIA and the Joint Chiefs of Staff for emergency plans in case of war. He also was the author of the Webb Staff Study that worked out cooperation between the military and the CIA concerning IAC intelligence-sharing of foreign atomic research with the AEC, which allowed the DCI prerogatives in the dissemination to key executive officials. Webb considered the DCI slot after Rear Admiral Hillenkoetter left office in 1950.

20. Top Secret Kennedy memorandum to the Director [of Counter Intelligence], Subject: Classification review of all UFO intelligence files affecting National Security, dated November 12, 1963.

21. *ibid*.

#### **Additional References**

For further updates and reports, see:

- [http://home.sprintmail.com/~rigoletto/tim\\_cooper\\_documents.html](http://home.sprintmail.com/~rigoletto/tim_cooper_documents.html)
- [http://home.sprintmail.com/~rigoletto/Sanctuary\\_Of\\_The\\_Birds.htm](http://home.sprintmail.com/~rigoletto/Sanctuary_Of_The_Birds.htm)







## ANOTHER ALLEGED ROSWELL WITNESS TELLS HIS STORY

*The following item comes via CNI News, with thanks to George Filer (Majorstar@aol.com), editor and publisher of Filer's Files (www.filersfiles.com), for permission to reproduce this eyewitness testimony. The item was first published in Filer's Files #14, dated April 10, 2000.*

In answer to an inquiry from CNI News, George Filer explained that he had recently received an unsolicited e-mail from a Filer's Files reader, giving the name and e-mail address of a man allegedly involved in the Roswell UFO incident of 1947.

Filer contacted the man—who wishes to remain anonymous, but whose name is known to CNI News—and exchanged several e-mails, from which the following account was assembled. To date, the witness has declined to discuss these matters with Filer by phone.

CNI News and several well-known Roswell researchers have requested direct contact with this man, but as of April 16 that request remains unanswered.

Filer, an Air Force veteran, told CNI News that, while he cannot vouch for the authenticity of this witness, the man does sound as if he is genuinely familiar with details of B-29 aircraft and flight procedures. In addition, a well-known Roswell

researcher confirmed that the name given by this witness is a name that can be positively linked to Roswell Army Air Field at the time of the Roswell incident.

The witness gave this account to George Filer:

**There had also been rumors for a couple of days about a spaceship crash, but we were only told it was classified cargo and to stay back.**

I was at Roswell in 1947 to early 1950. I was at the time a gunner in the 393rd Bomb Squadron, 509th Bomb Group, and a member of Captain Frederick Ewing's B-29 combat crew, with tail number 44-7301 (Straight Flush).

On Wednesday, July 9, 1947, our crew transported a crate to Carswell Army Air Force Base, Fort Worth, Texas, in 1:55 minutes [from Roswell, a distance of about 425 miles in one hour, 55 minutes]. The mission and cargo were classified. The crate was hauled into the front bomb-bay,

and armed guards rode in that bomb-bay with the crate. When I removed the down lock, I saw a Major and a Technical Sergeant in the bomb-bay and some others in there. They rode the whole trip in the bomb-bay and did not return with us.

We flew unpressurized at about 8,000 feet. Our bombardier made a safety check of the shackles which held the platform secure. Those shackles were rigged so that the cargo could not be jettisoned.

The Corporal tail gunner and I saw the crate when we removed the down locks from the bomb doors. The crate was covered with a tarp when unloaded and taken away on a trailer at Carswell. I would guess the crate was about 12 x 6 x 6 feet.

The engineer and I talked about weight and balance. They evidently had not given him a firm figure on the weight. He said with a laugh, "As long as it isn't more than five thousand pounds, our center of gravity should be okay."

We knew that Fort Worth was to be our landing point... Someone made a remark about carrying "the General's furniture".

There had also been rumors for a couple of days about a spaceship crash, but we were only told it was classified cargo and to stay back.

On the way home, I went forward to chat with Warrant Officer Landry about [a] minor problem with a prop. We had the Curtiss Electrics [people there] and there

was concern that one of them was hunting a bit.

Major Jesse Marcel rode back to Roswell with us and I talked briefly with him. He was always interested in the enlisted men on flight crews. He wanted gunners to be good observers when on long missions. I don't think his questions that day were probing... He asked if I was anxious to get into B-36s [the newest Air Force bomber at that time].

We were told repeatedly not to talk of this incident, not even to our wives. I held that inside until 1988, when books began to appear. To this day, I am in touch with one other member of our crew. Most of the others are no longer alive. Major Ewing was killed in a B-47 crash in Florida in 1952.

Some time afterwards, about three to six months later, the wives began talking among themselves about the clean-up detail. This originated from the wives of men on that duty. One such was a neighbor of ours in July 1947. They moved across town, but I would sometimes see him, and I asked him what he had seen out there. He was upset and told me, "You don't want to know." Based on the wives' gossip, we heard that he had seen a body.

Later, I became a pilot, and while in SAC [Strategic Air Command] was an instructor in the aero clubs and moonlighting as a crop duster. Aviation has been my life. While in SAC...at March AFB, our crew had two weird experiences with something that officially wasn't there.

[Signed] A Roswell B-29 gunner

George Filer adds this note:

"The government claims what was brought to Fort Worth under guard was a Mogul balloon, [the type] that they launched regularly from White Sands Proving Grounds, with printed instructions on the side for [how to obtain] a reward, if found.

"Our witness claims there were multiple guards inside the bomb-bay. Even atomic bombs did not normally warrant guards inside the bomb-bay, and certainly not an officer with the rank of Major."

CNI News notes that, assuming the testimony is true, whatever was carried in that bomb-bay was regarded by Roswell and/or Carswell military commanders as being of the utmost importance (perhaps more important than an atomic bomb).

Major Jesse Marcel flew on a different

plane to Carswell, as ordered by his commanding officer Colonel William Blanchard, accompanying samples of debris that the military would publicly identify as parts of a "weather balloon".

Marcel apparently had nothing to do with whatever was in the bomb-bay in the large box described by this witness, and might

**The city had apparently been abandoned ages ago, and the entire underground system looked very ancient.**

not have known anything about it.

This account is consistent with previously published claims that bodies and wreckage from a genuine UFO crash near Roswell were flown in one or more large crates by B-29 to Carswell, from which they might then have been dispatched to their final destinations, possibly including Wright Field (Wright Patterson Air Force Base) in Dayton, Ohio.

(Source: CNI News, USA, telephone +1 970 282 7077, e-mail CNINews1@aol.com, website www.cninews.com/)

## ANCIENT CITY BENEATH CALIFORNIA'S DEATH VALLEY?

**B**ourke Lee, in his book *Death Valley Men* (MacMillan, NY, 1932), in the chapter titled "Old Gold", describes a conversation he had several years before with a small group of Death Valley residents. The conversation eventually turned to the subject of Paiute Indian legends.

At one point, two of the men, Bill and Jack, described their experience with an "underground city" which they claimed to have discovered after one of them fell through the bottom of an old mine shaft near Wingate Pass.

They said they found themselves in a natural underground cavern which they followed about 20 miles north into the heart of the Panamint Mountains. To their amazement, they allegedly found themselves in a huge, ancient, underground cavern city. They claimed to have discovered within the city several perfectly preserved "mummies" which wore thick armbands,

wielded gold spears, etc. The city had apparently been abandoned ages ago, and the entire underground system looked very ancient. It formerly had been lit, they found out by accident, by an ingenious system of lights fed by subterranean gases.

They claimed to have seen a large, polished, round table which looked as if it may have been part of an ancient council chamber, giant statues of solid gold, stone vaults and drawers full of gold bars and gemstones of all kinds, heavy stone wheelbarrows which were perfectly balanced and scientifically constructed so that a child could use them, huge stone doors which were almost perfectly balanced by counterweights, and other incredible sights.

Bill and Jack also claimed to have followed the caverns upwards to a higher level which ultimately opened out onto the face of the Panamints, about halfway up the eastern slope, in the form of a few ancient tunnel-like quays. They realised that the valley below had once been under water, and they eventually came to the conclusion that the arched openings were ancient "docks" for sea vessels. They could allegedly see Furnace Creek Ranch and Wash far below them.

They told Bourke Lee that they had brought some of the treasure out of the caverns and tried to set up a deal with certain people, including scientists associated with the Smithsonian Institution, in order to gain help to explore and publicise the city as one of the "wonders of the world".

These efforts ended in disappointment, however, when a "friend" of theirs stole the treasure (which was also the evidence). They were scoffed at and rejected by the scientists when they went to show them the "mine" entrance and could not find it. A recent cloudburst, they claimed, had altered and rearranged the entire countryside; the landscape no longer looked the same.

When Bourke Lee last heard from the two men, Bill and Jack were preparing to climb the eastern face of the Panamints to locate the ancient tunnel openings or quays high up the side of the steep slope. Lee never did see or hear from his friends again.

In 1946, a man calling himself Dr F. Bruce Russell, and claiming to be a retired physician, told a similar story about finding strange underground rooms in the Death Valley area in 1931. He told of a large room with several tunnels leading off in different directions. One of these tunnels

led to another large room that contained three mummies. Artifacts found in the room appeared to be a combination of Egyptian and American Indian design. The most amazing thing about the mummies, though, was the fact that they were more than eight feet tall.

Dr Russell and a group of investors formed Amazing Explorations, Inc. to handle the release and profit from this remarkable find. But, as stories of this type usually go, Russell disappeared and the investigators were never able to find the caverns and tunnels again, even though Russell had personally taken them there. The desert can be very deceptive to anyone not used to travelling in it.

Months later, Russell's car was found abandoned, its radiator burst, in a remote area of Death Valley. Russell's suitcase was still in the car.

The old TV series *Death Valley Days* once ran a short story about western pioneers finding mummies in the desert. Since one of the scriptwriters stated that "there had never been a script without a solid basis in fact", it would be interesting to find out what their source had been.

For now, these stories will have to be shrouded in mystery, along with the account of the 21,000-year-old bones found in California's Imperial Valley, which were also rumoured to have been spirited off by the Smithsonian.

(Source: [www.geocities.com/TheTropics/Lagoon/1345/valley.html](http://www.geocities.com/TheTropics/Lagoon/1345/valley.html))

## NEW ARCHAEOLOGICAL FINDS IN MEIDUM PYRAMID

The pyramid of Meidum, one of Egypt's earliest pyramids, is a complicated structure, even by ancient Egyptian standards. It was built about 2600 BC, but its designers apparently couldn't make up their minds on what it should look like.

And now, French and Egyptian archaeologists, armed with a fibre-optic endoscope (like those which doctors use to peer inside the human body), have discovered two previously unknown chambers and a tunnel that stretches nearly 40 metres (131 feet) into the heart of the enigmatic pyramid.

The structure began as a step pyramid, with stair-step sides like a giant wedding cake, in the style of the famous "first pyramid" built at Saqqara for Pharaoh Djoser. Then the steps were expanded by adding another layer. Finally, its steps were

encased in a smooth shell to create one of the first true pyramids. Situated 90 kilometres (56 miles) south of Cairo, it rises nearly 100 metres (330 feet). Quite likely it was unstable from the beginning, and it seems never to have been used as a tomb.

**Archaeologists have discovered two previously unknown chambers and a tunnel that stretches nearly 40 metres (131 feet) into the heart of the enigmatic pyramid.**

A tunnel shaft leads from the outside of the mostly collapsed pyramid to the burial chamber deep inside. But, as Gaballah Ali Gaballah told the Eighth International Congress of Egyptologists in Cairo on Thursday 30 March, two recesses near the bottom of the shaft have confused archaeologists. (Gaballah is head of Egypt's Supreme Council of Antiquities.)

Each recess is about 1.7 metres (5.7 feet) high and 2.1 metres (6.9 feet) across. An unreinforced span of that size should be too great to support the enormous weight of the stone blocks above it. But the Franco-Egyptian team thinks it has solved the mystery.

Examination of the masonry along the top of the shaft revealed what looked like a carefully concealed window. In May 1998, the researchers slipped an endoscope — "a device like a long, flexible telescope about the diameter of a human finger" — through a joint

between building blocks. What they saw through the scope was another tunnel directly above the first. And this one had a "corbelled" roof—a top built of overlapping blocks that rise progressively to a point. Such a roof would distribute the overlying weight and relieve pressure on the open corridor below it. The new shaft does not open onto the outside of the pyramid, but it does head down towards the two troublesome recesses.

Last year, the team used the endoscope to explore beyond the end of the tunnel and above the recesses. What they found were two identical corbelled chambers, one above each recess and the same width. This rather clever, weight-distributing construction likely explains how the flat-roofed recesses were made possible.

Gaballah notes that the exact purpose of the complex recesses, chambers and twin shafts is not clear: "The work is still in progress and we don't know what to expect."

In addition to Gaballah, the team included Mustafa El-Zeiri of Egypt and Gilles Dormion and Jean-Yves Verd'hurt of France.

(Source: By Robert Locke, 12 April 2000, [http://foxnews.com/science/egypt/egypt\\_meidum.sml](http://foxnews.com/science/egypt/egypt_meidum.sml))







# REVIEWS

## BOOKS

Reviewed by Ruth Parnell

### THE TOXIC PLAYGROUND

by Jo Immig

Publisher: Total Environment Centre, Sydney, Australia, 2000

ISBN: 0-947360-16-6 (104pp tpb)

Price: AUD\$23.00 + \$3 p&h in NSW, \$5 other states, \$6 to NZ, \$10 elsewhere

Available: **Australia**—Total Environment Centre, 362 Kent Street, Sydney, NSW 2000, tel +61 (0)2 9299 5599, fax +61 (0)2 9299 4411,

website <http://tec.nccnsw.org.au/>

Environmental scientist Jo Immig, an anti-chemicals campaigner for the Sydney-based Total Environment Centre, wrote *The Toxic Playground* to alert us to the dangers children face at home, at school and at child-care centres from the toxic chemical load that causes "sick building syndrome" and a host of human health problems. Knowing how vulnerable children are to exposure, she is on a mission to promote risk-reducing strategies.

The huge increases in recent years in childhood asthma, multiple chemical sensitivity, chronic fatigue, so-called attention deficit disorder and food allergies/intolerances must be seriously viewed against the onslaught by environmental chemicals (many of which have endocrine-disrupting effects) as well as toxic food additives. Innig gives a brief overview of toxicology and highlights some of the most dangerous substances including lead, volatile organic compounds, formaldehyde, solvents and combustion products. She gives tips on identifying, auditing and removing the chemical pollutants that are

outgassed by carpet, furniture, panels, glue, dyes, paints, photocopiers, and many of the items which children use for playing and learning. She also stresses the importance of maintaining good indoor air quality and ventilation.

Innig also looks at chemical risk reduction policies and strategies in Australia and the United States. Her slim but invaluable book is an accessible read and presents case histories, checklists, safe alternatives as well as resources and references. This is essential information to act upon to help children grow up to lead healthy, fulfilling lives.

### GLOBAL SPIN: The Corporate Assault on Environmentalism

by Sharon Beder

Publisher: Scribe, Australia, 2000, rev. ed.

ISBN: 0-908011-44-X (336pp tpb)

Price: AUD\$29.95; NZD\$44.95; £10.95

Available: **Australia**—Scribe Publications, tel (03) 9349 5955, e-mail [scribe@bigpond.net.au](mailto:scribe@bigpond.net.au); **NZ**—Addenda, tel (09) 834 5511; **UK**—Green Books, tel 01803 863260 (1997 edition only)

It should come as no surprise to NEXUS readers that corporations employ sophisticated techniques to persuade public opinion in favour of various agenda they wish to push. The environment is one area where their drive is particularly relentless. As Dr Sharon Beder explains in *Global Spin*, corporations utilise industry-funded scientists, specialist public relations companies, the media, conservative think-tanks and the legal system to win over the hearts and minds of politicians and the people.

When *Global Spin* was first published in 1997, it was ignored by the mainstream media, and it would be unfortunate if this

newly revised Australasian edition had a similar response. This one has three new chapters covering corporate-sponsored confusion on global warming, the "greenwashing" of the Sydney 2000 Olympics, and Greenpeace's adoption of a solutions-based approach with industry that is arguably at odds with its "green warrior" stance.

Dr Beder is an engineer and associate professor in science, technology and society at the University of Wollongong, Australia. Her analysis is an indictment of the way our environmental problems are managed in this PR mega-spin era. The lead-up to Sydney's once so-called "Green Games" is a classic example of how a major problem of a former toxic waste dump on the site can be stage-managed and the public duped into thinking the problem has been solved.

If you're concerned about the environment, read this book to be wiser to the tactics utilised to protect corporate vested interests.

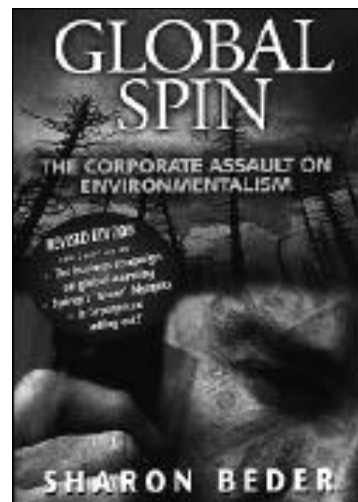

# REVIEWS



## BOOKS

### CELTIC MYSTERIES IN NEW ENGLAND

by Philip Imbrogno and Marianne Horrigan

Publisher: Llewellyn, USA, 2000  
ISBN: 1-56718-357-3 (164pp tpb)  
Price: AUD\$25.95; NZD\$35.95; £9.99;  
USD\$12.95; CAD\$19.95

Available: **Australia**—Banyan Tree, tel (08) 8363 4244; **NZ**—Peaceful Living, tel (07) 571 8105; **UK**—Airlift Book Co., tel 020 8804 0400; **USA**—Llewellyn, tel 1-877 639 9753, www.llewellyn.com

Scattered through the woodlands of New York state and New England are hundreds of stone chambers. Constructed of hewn slabs of granite, quartz, limestone and shale, these rectangular, oval and circular chambers were built up at 20° angles on the sides, were supported by a massive slab on top with allowance for a doorway, and were covered with soil. Curiously, they don't all show the same weathering patterns, so it's likely they were built over a very long time.

Science teacher Philip Imbrogno and paranormal researcher Marianne Horrigan have spent much of the last two decades investigating these enigmatic chambers. In *Celtic Mysteries in New England*, they conclude that the chambers significantly pre-date colonial times and were used for astronomical, ritual and burial purposes. They determined with instruments that the chambers are sited in areas of strong magnetic anomaly. Because many of them are found alongside far older megalithic stone markers, the authors suggest that earlier peoples had

already tuned into the local landscape energies and even interdimensional portals. A diverse range of paranormal activity has also been recorded around these sites.

The authors have found evidence for several waves of chamber builders over millennia: the Phoenicians, from around 2500 BC, then Iberian Celtic mariners around 1200 BC, followed by Irish Druids and, later, Celts and Irish Christian monks from AD 500 and for centuries beyond. Their findings add another key piece towards unlocking the true history of ancient exploration.

### THE TUTANKHAMUN PROPHECIES by Maurice Cotterell

Publisher: Headline, UK, 1999, 2000 (pb)

ISBN: 0-7472-6050-8 (356pp pb)

Price: AUD\$19.95; NZD\$29.95; £7.99

Available: **Australia**—Hodder Headline, tel (02) 8248 0800; **NZ**—Hodder Moa Beckett, tel (09) 478 1000; **UK**—Headline, tel 020 7873 6000, www.headline.co.uk

Following on from where he left off in *The Mayan Prophecies* and *The Supergods*, author/engineer/scientist Maurice Cotterell adds the 18th dynasty Egyptian boy-king to his reincarnating pantheon in his latest book, *The Tutankhamun Prophecies*. Having studied the artefacts, he believes that the Pharaoh Tutankhamun (1333–1323 BC) was one and the same as Lord Pacal, also a boy-king, who brought knowledge and wisdom to the people of Mexico over 1,250 years ago.

Both of them were known as the "feathered snake"—a symbolic representation of the Sun and its sunspot cycles including its "neutral warp", Cotterell explains. Both had encoded within their tombs, death masks and adornments this vital knowledge of the

Sun and its effects on fertility, as well as knowledge of the nature of light and the immortal soul. They both prophesied destruction, and the collapse of their dynasties coincided with sunspot minima.

Cotterell believes this ancient knowledge of sunspot cycles and soul reincarnation was not lost but protected by secret societies, including members of higher Freemasonic orders who coded aspects of it into the mediaeval cathedrals of Europe. Now, scientists are finding the keys to what the "gods" left for us to decode on how the Sun controls fertility and biorhythms, determines personality, causes cancers and affects the rise and fall of civilisations. Cotterell includes detailed appendices on all this and more in this richly illustrated volume. His findings are awesome and have serious implications for our future, the more we learn about the Sun's strange behaviour.

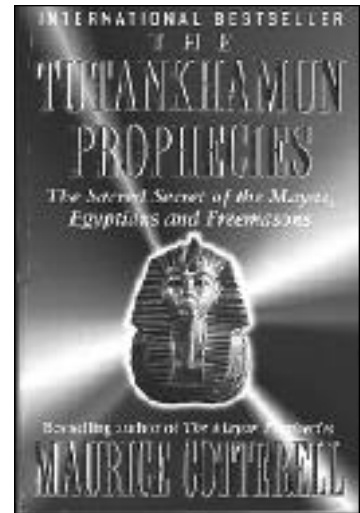



# REVIEWS

## BOOKS

### ROSWELL 1947: "I WAS THERE"

by Robert J. Shirkey

Publisher: Movin' On Publishing, 2000  
ISBN: 0-9671465-0-X (154pp tpb)

Price: USD\$15.95 + \$3.50 p&h in USA  
(postage elsewhere, contact publisher)

Available: **USA**—Movin' On Publishing, Inc., PO Box 2664, Roswell, NM 88202, tel 1-877 482 7474, fax (505) 622 5278, e-mail movinon@dfn.com, website www.roswellincident.com

We haven't heard the end of the Roswell incident yet, for witnesses are still coming forward with their recollections of the July 1947 alleged UFO crash/retrieval event. One such account is from Robert Shirkey, who at the time was a First Lieutenant and Assistant Group Operations Officer of the 509th Bomb Group based at the Roswell Army Air Field, New Mexico.

Shirkey attests to seeing metallic fragments (including a small "I-beam") from the alleged crash site being carried through the Operations building at the air field—one of the carriers being Major Jesse Marcel—and loaded aboard a waiting B-29 aircraft bound for Fort Worth. This was on 8 July 1947; ten days later, he was transferred to The Philippines. Had he seen too much?

In his account, *Roswell 1947: "I Was There"*, Shirkey provides additional material from Frank Kaufmann, a longtime Roswell resident and former Army Air Force radar operator who'd seen an unexplained "blip" disappear on the radar screen during an electrical storm on the night of 3 July 1947. The craft and its occupants, Shirkey claims, were located and whisked away by the military

before sunrise the next morning.

Shirkey broke his silence in 1990 when, with fellow Roswell witness Walter Haut, he spoke out at a UFO conference, though he says he was never told to keep quiet about what he'd seen or heard that day. His written account—a memoir plus a record of stories from witnesses whose integrity he trusts—is a worthy addition to the lore.

### THE OUT-OF-BODY EXPERIENCE by Graham Dack

Publisher: Oobex, UK 1999

ISBN: 0-9534458-0-1 (296pp pb)

Price: £13.95 (includes postage and handling to anywhere on the planet)

Available: **UK**—Oobex Publishing, tel/fax +44 (0)1788 891514, website www.oobex.freemove.co.uk

There's no substitute for personal experience when acquiring knowledge and wisdom is concerned; so when it comes to out-of-body experiences, no one else can do it for you, but it helps if they can give a few pointers. Graham Dack does this admirably in *The Out-of-Body Experience*. He's a self-taught explorer of other dimensions, and here he explains in simple terms his unique understanding based on 25 years of studying sleep and dream processes and projections into etheric, astral and spiritual realms.

Providing background on himself and his discoveries first of all, Dack then explains the ins and outs of etheric, astral and spirit projection, the landscapes of dreams, and practical techniques for learning how to relax—a prerequisite before embarking on an out-of-body journey.

He covers the record-keeping process, questions relating to religion, morality and health, as well as some of the multifarious

encounters that can be had "out there".

Out-of-body projection has been a fundamental human activity for many thousands of years, and Dack maintains it can be practised and mastered by anyone with the will, discipline and patience to stick with it—though he concedes that some people seem to have greater ease than others in achieving this. He says that as you become more familiar with the technique, the subconscious mind adjusts to the idea that it is normal for the spirit-body to exist outside the physical body; indeed, both the soul and the conscious mind use the spirit-body as a vehicle and are not fixed in the physical. Such projection is often cloaked in dreams.

Dack portrays with humility and wonder this most exhilarating of human experiences. His user-friendly guide is a beacon for those on a journey of self-discovery.



# REVIEWS



## BOOKS

### VACCINATION: The Right Choice?

by Maureen Hickman

Publisher: M. Hickman, Australia, 2000

ISBN: 0-646-38724-3 (246pp pb)

Price: from NEXUS, AUD\$28.00 includes postage within Australia; NZ p&h add AUD\$8.50; UK/Europe/USA p&h add AUD\$10.00

Available: **Australia**—NEXUS Magazine, tel (07) 5442 9280; or Maureen Hickman, PO Box 274, Ettalong Beach, NSW 2257, tel (02) 4342 5294, fax (02) 4342 5379, e-mail acii@ozemail.com.au

The question of whether or not to have one's child vaccinated is a dilemma for parents; but the more information they have, the more confident they can be in exercising their right to "informed consent". It is in this spirit of enquiry that Maureen Hickman has written *Vaccination: The Right Choice?*

Sydney-based Hickman has drawn on her 25 years of para-legal experience and her expertise in research for legal claims by vaccine-damaged individuals. Much of the data she presents relates to Australian cases and circumstances, but she also covers developments in the USA, UK and Europe.

Hickman addresses the confusion surrounding the withholding of child care payments to Australian parents who refuse to have their children vaccinated, and details consumer rights under the various applicable Acts in Australia, NSW in particular.

She looks at how the Australia Card we didn't want is in effect being revamped via the Australian Childhood Immunisation Register, and chides the government for its

failure of duty in not establishing a system for reporting vaccine adverse effects. Most childhood vaccines, she says, are not put through proper clinical trials before being foisted on the defenceless, so the official line that "the benefits far outweigh the risks" is an untested myth until the benefits/risks can be accurately quantified.

With comprehensive information on the make-up and effects of vaccines as well as the vested interests in political, medical, pharmaceutical and media fields, Hickman's book is a great contribution to helping parents decide without feeling intimidated.

### MAGICAL AND MYSTICAL SITES: Europe and the British Isles

by Elizabeth Pepper & John Wilcock

Publisher: Phanes Press, USA, 2000

ISBN: 0-933999-44-5 (300pp tpb)

Price: £13.99; USD\$16.95 + p&h

Available: **UK**—Airlift Book Co., tel 020 8804 0400; **USA**—Words Distributing Co., 1800 593-WORD; Phanes Press, tel (610) 456 5740, e-mail phanes@cris.com, website www.phanes.com

Most of us will never get to visit all the ancient, sacred places which are the foundation of Western occult traditions, but this book, *Magical and Mystical Sites*, is a suitable alternative for those who at least dream of undertaking such a quest.

Authors Elizabeth Pepper and John Wilcock take the reader on a magical mystery tour of Europe and Britain, starting in Ephesus, Turkey, then moving on to the Aegean islands and Greece, Malta, Italy, Spain and the Basque region, and then to France and southern Germany and over to the British Isles. They include a wealth of

historical, archaeological, religious and cultural data but contextualise it within the mythical, folkloric and occult background.

The authors identify two major themes to Western magical thinking—one shaped and energised by the Greeks in the first millennium BC; the other, a much more ancient tradition extant thousands of years earlier. They found evidence of the latter on Malta in the Hypogeum subterranean temple, and in Ireland in the legacy of the pre-Celtic Tuatha Dé Danann.

Taking in the Temple of Artemis at Ephesus and the Oracle at Delphi; the cave art of Altamira and the menhirs of Brittany; Stonehenge in Wiltshire, England, and the raths of Ireland...this travelogue of sacred places, where the natural world meets the supernatural, conveys the message that Western heritage is far more esoteric than we generally acknowledge.

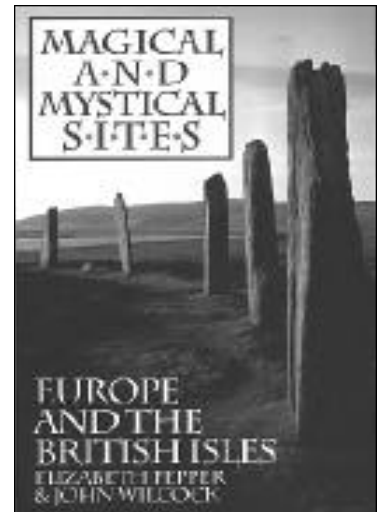



# REVIEWS

## BOOKS

### THE LIVING ENERGY UNIVERSE

by Gary Schwartz, PhD, and Linda Russek, PhD

Publisher: Hampton Roads, USA, 1999  
ISBN: 1-57174-170-4 (288pp hc)  
Price: AUD\$47.95; NZD\$62.95; £16.99; USD\$21.95

Available: **Aust**—Gemcraft, tel (03) 9888 0111; **NZ**—Peaceful Living, tel (07) 571 8105; **UK**—Airlift Book Co., tel 020 8804 0400; **USA**—Hampton Roads Publishing Co., tel (804) 296 2772, fax (804) 296 5096, website www.hrpublish.com

In *The Living Energy Universe*, Gary Schwartz and Linda Russek attempt to unify science and spirituality via their systemic memory hypothesis. Central to their model is the notion that all systems, from the most microscopic to the universal, are eternal, alive and evolving and, as such, have eternal, living, evolving memories.

Dr Schwartz, a professor of medicine, neurology and psychiatry but with a focus on integrative and bioenergetic medicine, set upon the idea in the early 1980s when studying systems theory. But it wasn't until 1993 that he and Dr Russek, also a medical professor involved in energy medicine, began to develop the hypothesis—and in response to a question about life after death.

The authors argue that the systemic memory process is facilitated by "recurrent feedback interactions" that occur between neurons and neural networks, within all cells and molecules. The idea of tapping into this "universal living memory" is not new; for instance, ancient Sanskrit teachings describe

the "Akashic records" and how to access them. Thankfully, the authors do acknowledge their debt to the ancients, and give due credit to more recent scientists/philosophers including Ken Wilber, Gary Zukav, Rupert Sheldrake, Stuart Hameroff as well as Bevan Reid—whose 1987 experiment on information transfer between crystals in Petri dishes they have replicated (their summary is in the appendices). Their simple, logical, elegant model, if accurate, has enormous implications for...everything.

### CYBERCULTURE COUNTER-CONSPIRACY: A *Steamshovel* Web Reader - Volumes 1 & 2

edited by Kenn Thomas

Publisher: The Book Tree, USA, 1999  
ISBN: 1-58509-125-1 (177pp tpb), 1-58509-126-X (125pp tpb)  
Price: £10.95 each + p&h; USD\$13.95 each + p&h

Available: **UK**—Counter Productions, tel 020 7274 9009; **USA**—The Book Tree, PO Box 724, Escondido, CA 92033, website www.thebooktree.com

Sooner or later, all good websites reach information overload; so when it came time for Kenn Thomas, publisher of the US conspiracy journal *Steamshovel Press*, to remove much of his website's material that had built up over the recent years, he had it collated and published in two book volumes (or, a laser imprint for the digitally inclined) as *Cyberculture Counterconspiracy*. Using this title, he pays tribute to Dr Timothy Leary, "the true champion of the cyberculture", and a host of mostly US-based conspiracy researchers and counterculture commentators, past and present.

The first book includes postings from the Latest Word column, with short features from *Steamshovel* contributors like Len Bracken, Adam Gorightly and the late Jim Keith; insightful interviews with Thomas himself, deceased activist/anarchist Kerry Thornley as well as JFK; and missives from fellow conspiracy journalists from *Paranoia!*, *The Excluded Middle* and the UK-based journal *Lobster*. The second volume contains reviews, news and posted links from the site's Offline Illumination and Things Are Gonna Slide columns. (But if only these volumes had contents or index pages to ease the navigation task...)

The material is mainly US-centric and ranges from the bizarre to the intriguingly interconnected, covering subjects/names as diverse as the occult, CIA mind control, the Manson family, UFOs, Reich, Castaneda, the globalisation agenda and the OKC bombing. Heady stuff for conspiracy buffs.

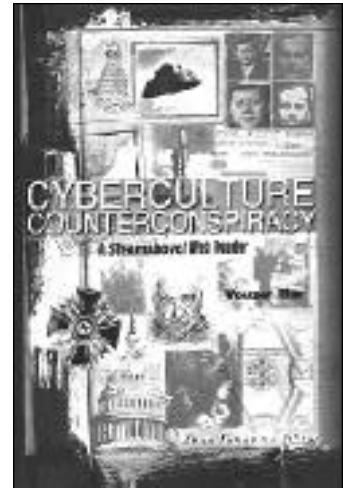

# REVIEWS



## BOOKS

### THE PEOPLE BEFORE (THE SECRET LAND Trilogy, Vol. 1) by Gary J. Cook and Thomas J. Brown

Publisher: StonePrint Press, NZ, 1999  
ISBN: 0-9582040-0-4 (225pp tpb)  
Price: NZD\$29.90; Australian orders,  
add NZD\$8.00 p&h, elsewhere add  
NZD\$15.00 p&h

Available: **New Zealand**—StonePrint  
Press, Post Box 55-037, Castle Hill Village,  
Christchurch 8020, tel +64 (0)3 318 7377,  
fax +64 (0)3 318 7311, e-mail info@  
stoneprint.co.nz, www.stoneprint.co.nz

The prehistory of New Zealand is far richer than the mainstream version of events concedes. The Polynesian Maori *iwi* (tribe) may have arrived after AD 1200, but it's believed that an earlier group arrived a thousand years earlier, only to find the land already populated with tall, light-skinned, fair-haired people, a darker people of smaller stature, and even vestiges of giants.



For *The People Before*, writer/historian/explorer Gary Cook and researcher Tom Brown, former editor of the *Borderlands* journal, have compiled this dynamic first book in a trilogy titled "The Secret Land", on New Zealand's hidden, alternative history. Both of them contribute an introductory chapter which must also serve as their final words, for in the end readers are left to mull over the facts and draw their own conclusions about the origins of *tangata whenua*, the earlier occupants of the islands. Many of these ancient artifacts, which include canals, pits, mounds and stone carvings, have been deemed "anomalous", their origins not part of Maori stories covering the last thousand or 1,800 years.

Cook and Brown present recent scientific findings as well as diverse archival accounts and illustrations from late 19th/early 20th century anthropological and archaeological sources which have been conveniently brushed aside over ensuing years. Among the evidence is that the Maori knew that New Zealand's flightless bird, the moa, was extinct before the first wave of their ancestors arrived, and that a much earlier people with links to Central and South America, Australia and the entire Pacific Ocean region occupied the land in ages past.

The authors treat their subject matter with sensitivity, but their controversial findings still leave many questions unanswered.

### THE PURE STATE OF NATURE

#### by David Horton

Publisher: Allen & Unwin, Aust, 2000  
ISBN: 1-86508-107-8 (192pp tpb)  
Price: AUD\$19.95; NZD\$27.95

Available: **Australia**—Allen & Unwin, tel +61 (0)2 8425 0100, e-mail frontdesk@allen-unwin.com.au; **NZ**—Archetype Book Agents, tel (09) 377 3800

In *The Pure State of Nature* Dr David Horton, scientist, archaeologist, farmer and editor of *Encyclopaedia of Aboriginal Australia*, launches an attack on the misconceptions of white Australian academia and culture over the last two centuries and presents a passionate argument for a different way of looking at Australia's prehistory.

Dr Horton takes exception to a view expounded by Dr Tim Flannery in *The Future Eaters*, that Aborigines used fire to the detriment of the environment and that they were responsible for the demise of the land's megafauna. He argues that their use of fire caused no more damage than a typical bushfire (which, he concedes, can be very destructive) and that large-scale use was not in the interests of their survival.

On the second point, Horton asks how the Aborigines, who have occupied Australia for 50,000 years (at least), could have killed off the megafauna when they co-existed for 25,000 years before the extinction. The "kill sites" proposed by some archaeologists are non-existent. The culprit, he maintains, was climate change. The megafauna, having adapted to climatic variations in preceding ages (like the other species, humans included) were cut off from adequate water supplies (as other species were not, due to better adaptations) when the lush interior was beset by an extended dry spell which caused desertification of key ecosystems.

With his personal, provocative approach, Dr Horton gives insights into the Aboriginal view of nature, and laments that the rampant ecological havoc inflicted on Australia these past 210 years has already caused disaster.



# REVIEWS

## BOOKS

### THE THREAD OF INFINITY

by Jon Whistler

Publisher: Light Pulsations, Aust, 2000  
ISBN: 0-9585489-8-6 (664pp tpb)  
Price: AUD\$35.00 in Aust; AUD\$40.00 to NZ; US\$30.00 elsewhere (prices incl p&h)  
Available: **Australia**—NEXUS Magazine, tel (07) 5442 9280; or Light Pulsations, PO Box 1447, Launceston, Tasmania 7250, tel +61 (0)3 6334 5195, fax +61 (0)3 6328 1539, website [www.ionitherapylife.com](http://www.ionitherapylife.com)  
*(Reviewed by Duncan Roads)*

It is not often that I get so drawn into one of the books on our eternal "reviews pile". I initially picked up this book to make an "executive decision" as to whether I would include the title for review in NEXUS, and ended up not being able to put the darn thing down! My concern was that the book was "visionary fiction" (a category I generally avoid including in NEXUS), and indeed, to this moment, I am still undecided as to whether I believe it to be literally true or not.

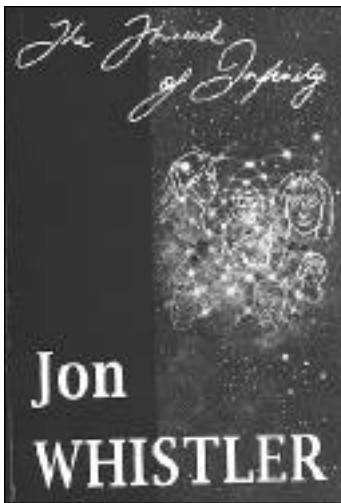

The tale starts in an ancient civilisation which is known to its inhabitants as "Lemu". The characters reappear in various guises and lifetimes at key points in the Earth's history: in Atlantis; Rome in the time of Julius Caesar; Judea in the time of Jesus Christ; an ancient American "Indian" civilisation; the time of Arthur and Merlin in ancient Britain; pre-World War II Nazi Germany; and on into the super-secret world of the Illuminati and the upper echelons of the global intelligence community.

It is the story of those who feed on the energy of fear so they can maintain their energy source. It is the story of those struggling to break through the boundaries of a deliberately created space-time illusion (plus

its attendant ego) and awaken to the energies of their God within—unconditional love.

This book is so well written, I had to pinch myself so I'd remember where I was each time I put it down. You, as the reader, are there, living each life, experiencing their feelings. It has so many echoes of historical accuracy that you will be left in eternal wonder as to where the information came from. I just cannot praise it highly enough!

### THE GRAND DESIGN, Volumes 1 & 2 by Paddy McMahon

Publisher: Hampton Roads, USA, 2000  
ISBN: 1-57174-154-2 (vol 1 200pp tpb); 1-57174-155-0 (vol2 226pp tpb)  
Price: AUD\$29.95 each; NZD\$38.95 each; £n/a; USD\$13.95 each  
Available: **Aust**—Gemcraft, tel (03) 9888 0111; **NZ**—Peaceful Living, tel (07) 571 8105; **UK**—Airlift Book Co., tel 020 8804 0400; **USA**—Hampton Roads Publishing Co., tel (804) 296 2772, [www.hrpub.com](http://www.hrpub.com)

As a child, Irishman Paddy McMahon was fascinated by fairies and angels, yet fearful of the hell, devil and evil spirits of his Catholic upbringing. Much later, at the age of 44, he began to see and hear spirit guides, and three years on, in 1981, had his first conscious communication with one whom he named "Shebaka". Fifteen years later, he learned that this highly evolved spiritual entity was once the Egyptian Pharaoh Shabaka (712–698 BC), who preserved an ancient scroll bearing Ptah's creation story in a stone carving—now held at the British Museum in London.

*The Grand Design* is a two-volume collection of Shebaka's higher-soul wisdom, channelled for the purpose of relaying insights to help individuals achieve their true spiritual potential. McMahon's original self-published edition was very well received, and it's easy to see why it gelled with so many people. Shebaka's messages have the clarity and authority of a being who has progressed through various stages of evolutionary development, and they ring true to those who are on a path of spiritual enquiry.

Volume 1 shares Shebaka's insights on God and the Grand Design, awareness and consciousness, the seven stages of evolutionary growth, time and space, group reincarnation, prophecy and even euthanasia and suicide. Volume 2 delves further into how the Grand Design translates into the reality of human experience; it considers unconditional love, sin and karma, imagination and meditation, soul mates and relationships, ETs and the Akashic records, as well as sex, politics, money and much more.

This is down-to-Earth wisdom, coming from a non-judgmental, loving space.

# REVIEWS



## BOOKS

### CONSPIRANOIA! The Mother of All Conspiracy Theories

by Devon Jackson

Publisher: Plume/Penguin, USA, 2000

ISBN: 0-452-28128-8 (200pp tpb)

Price: USD\$13.95; CAD\$19.99

Available: **USA**—Plume Paperbacks/  
Penguin Putnam Inc., tel +1 (212) 366  
2222, fax +1 (212) 366 2262

For those who like their conspiracy theories with a dose of humour, this book, *Conspiranoia!*, will make you smirk and grimace at the same time. It's also the ideal book to brush up with so you can amaze your friends at conspiracy quiz nights.

Author Devon Jackson, a freelance journalist whose work has been published in *The Village Voice*, *Rolling Stone*, *Vanity Fair* and *New York Times*, has been exploring the vast conspiracy territory for over a decade. He has a special mix of wit and irony in his reporting, lifting the reader out of despairing too much over who "They" really are.

In describing the territory of 20 major conspiracy theories, Jackson starts out with "maps"—appealingly hand-drawn diagrams showing links between the main themes and players. The text begins with his analysis of the "Master Plan", which includes God, Satan, the Illuminati, Freemasons and Nazis as well as the NWO, CIA, FBI, LSD, CFR, TNCs, ETs, the Aquarian Conspiracy and many other lesser-known groupings. He then focuses on sub-conspiracies, with catchy chapter names like Dark Knights, Freemalluminati, Zionist Anti-Zionist, Ameryan, Reactioneers and Schizodelic.

The entries in each category are brief but pithy, and they're compiled with photos and

quotes in a nicely anarchic layout. Chapters are not numbered, but symbolised; the same icons are used in the text where appropriate to aid cross-referencing (though this takes some getting used to).

Jackson sums it up when he describes "conspiranoia" as the grey area between what you *know* is true and what you *feel* is true. A book I wish I'd written myself!

## VIDEO

Reviewed by Duncan Roads

### UFO DOWN-UNDER

Produced by Barry Taylor, Australia, 2000 (PAL/VHS or NTSC/VHS, 50mins)

Price: AUD\$40.00 inc. p&h in Australia; AUD\$47.00 elsewhere

Available: **Australia**—Barry Taylor, PO Box 679, Grafton, NSW 2460, e-mail stingray@nor.com.au, website [www.nor.com.au/users/stingray/](http://www.nor.com.au/users/stingray/)

The area of Grafton in the northeastern corner of New South Wales, Australia, has long been considered a "hot spot" for unusual and unexplained phenomena. Whilst many researchers are aware of the many reported UFO sightings, as evidenced by scores of local newspaper reports over the years, not so many people are aware that the hills behind Grafton have more than their fair share of sightings of strange creatures, including 30-foot-long lizards and, of course, the elusive yowie.

Barry Taylor is to be congratulated for this fine-quality production. Good visuals and soundtrack as well as clear narration add up to make a very watchable video.

Features on the video include:

- The "Jellyfish" UFO—an eight-minute daytime sighting of a most unusual object that had an appendage dangling from underneath. The object appeared to be "swimming" because of its unusual movement, and using this "tail" to propel itself. As the object gets further away, you can clearly see it pulsing. Zoomed close-ups of the object show the "tail" action.

- "Cluster" UFOs—the footage of this 50-minute daytime sighting is considered by many to be the best ever taken of these. Five different "clusters" are featured, with zooms showing their unusual action of rolling around one another. The sighting includes orange and blue spectrum UFOs. When these objects fly in front of cloud, you can see their upright cylinder shape; these are also zoomed so you get a better look.

Other highlights include still images of the UFO flap of April 1998; low, slow-flying UFOs over Grafton at night; and a "triangle formation" of UFOs just west of the town.

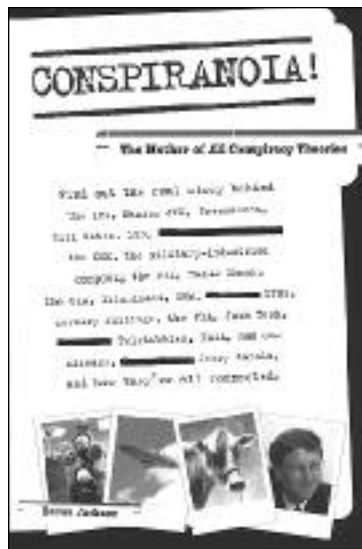



# REVIEWS

## MUSIC

Reviewed by Richard Giles

### TARALINGA LILA

by Sangeet, Tarshito, Jimmy

Producer: Tarshito for Kittani Music, NSW, Australia, 1999 (57mins)

Distributor: **Australia**—Kittani Music, tel +61 (0)2 6684 2350, website <http://users.mullum.com.au/tarshito>

One of Australia's unique and refreshing ambient performers, Tarshito has been producing music since 1989 and doing it well. Earlier releases like *One Moment*, *Travellers Tales* and *Dreams of Passion* have been gentle, cross-cultural pieces of ambient, uplifting, fusion music. The latest, *Taralinga Lila*, featuring fellow musos Sangeet and Jimmy, is an exciting mix of West and East, with sitar, cello, percussion, guitar and didgeridu, that sails along in a rhythmic flow of Indian-inspired, percussive dancing sound. A lively, celebratory album.

### REPUBLICA DOMINICANA

by various artists

Producer: Dan Storper for Putumayo World Music, NY, USA, 2000 (41mins)  
Distributors: **Aust**—MRA, tel (07) 3849 6020; **USA**—Putumayo Music, tel 1888 788 8629, website [www.putumayo.com](http://www.putumayo.com)

Another in the great Putumayo catalogue, this time from the Dominican Republic. The most famous music from the island is the style known as *merengue*. It's an exciting dance rhythm that's found throughout the Caribbean. Usually the music is played by a large ensemble that includes saxophones, trumpets, brass and keyboards, with a bunch of peppy singers who do their stuff with lots of great choreography. The other form is *bachata* which features the bongos and the requinto, a small guitar. This hot collection pushes both styles and will have you up on your feet for every track.

### BEYOND SKIN

by Nitin Sawhney

Producer: Nitin Sawhney for Outcaste Records, London, UK, 1999 (58mins)

Distributors: **Aust/NZ**—Festival Records; **UK**—Outcaste Records, website [www.outcaste.com](http://www.outcaste.com)

Identified by an extraordinary cover image of a bust of a crying man, *Beyond Skin* is among the best British/Asian experimental fusion pieces of the year. Nitin states: "My identity and my history are defined only by myself—beyond politics, beyond nationality, beyond religion and beyond skin." A mix of upbeat, fused and synthesised sound,

techno, flamenco, jazz, traditional instruments and political statements makes this an exciting exploration of the musical boundaries of the best new Indo-tradition.

### TRIBE

by Tribe

Producer: David Pendragon for Pentacles Music, Aust, 1999 (61mins)

Distributors: **Aust**—One World Music, tel (07) 3367 0788; **UK**—One World, tel 01986 781682; **USA**—One World, tel 1800 7710987, website [www.new-worldmusic.com](http://www.new-worldmusic.com)

Journeying into a mix of tribal cultures has been the goal of Tribe members David Pendragon, Bill Hall and Wayne Miller. Here they combine mixes from Asia, Africa and the Pacific with their own brand of world tribal music. Bringing together keyboards with dulcimer, flute, accordion, bass and percussion, they have captured the sounds of diverse cultures from around the planet. This is a very listenable album of laid-back world fusion. Recommended.

### SHAFQAT ALI KHAN

by Shafqat Ali Khan

Producer: Douglas McKeehan for World Class Music, USA, 2000 (55mins)

Distributors: **Aust**—MRA, tel (07) 3849 6020; **USA**—World Class Music, tel (415) 331 3200, website [www.world-classmusic.com](http://www.world-classmusic.com)

The tradition of *gharana*-singing is one that can be traced back centuries in the Indian and Pakistani classical musical lineage. Shafqat Ali Khan's own musical family line goes back to the 16th century. Here he is enhanced by an electrified musical backing with keyboards and guitars plus traditional instruments, the udu, dhumbek, tabla, kanjira and shakers, to produce a more exotic, blended sound. An intriguing album that successfully manages to cross the boundaries between ancient and modern.

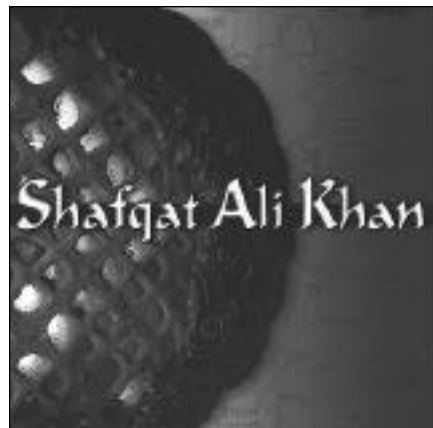



Continued from page 36

uptake by astrocytes as well, which would significantly increase extracellular glutamate levels.<sup>43</sup> This creates a vicious cycle that will multiply any resulting damage and malfunctioning of neurophysiological systems, such as plasticity.

### Endnotes

1. Ikonomidou, C. and Turski, L., "Glutamate in Neurodegenerative Disorders", in Stone, T.W. (ed.), *CNS Neurotransmitters and Neuromodulators: Glutamate*, CRC Press, Boca Raton, 1995, pp. 253-272.
2. Whetsell, W.O. and Shapira, N.A., "Biology of Disease. Neuroexcitation, excitotoxicity and human neurological disease", *Lab. Invest.* 68:372-387, 1993.
3. Lucas, D.R. and Newhouse, J.P., "The toxic effect of sodium L-glutamate on the inner layer of the retina", *Arch. Ophthalmol.* 58:193-201, 1957.
4. Olney, J.W., "Brain lesions, obesity, and other disturbances in mice treated with monosodium glutamate", *Science* 165:719-721, 1969.
5. Pol, A.N.V., Wuarin, J.-P. and Dudek, E., "Glutamate, the dominant excitatory transmitter in neuroendocrine regulation", *Science* 250:1276-1278, 1990.
6. Coyle, J.T. et al., "Excitatory Amino Acid Neurotoxins: Selectivity, Specificity, and Mechanisms of Action", *Neurosci. Research Bull.* 19(4), 1981.
7. Blackstone, C.D. and Haganir, R.L., "Molecular Structure of Glutamate Receptor Channels", in Stone, T.W. (ed.), *CNS Neurotransmitters and Neuromodulators: Glutamate*, CRC Press, Boca Raton, 1995, pp. 53-67.
8. "Analysis of Adverse Reactions to Monosodium Glutamate (MSG)", Life Sciences Research Office, FASEB, July 1995.
9. Blaylock, R.L., *Excitotoxins: The Taste That Kills*, Health Press, Santa Fe, 1997, pp. 248-254.
10. Olney, J.W., "Glutamate: a neurotoxic transmitter", *J. Child Neurol.* 4:218-226, 1989.
11. Choudhary, P., Malik, V.B. et al., "Studies on the effect of monosodium glutamate on hepatic microsomal lipid peroxidation, calcium, ascorbic acid and glutathione and its dependent enzymes in adult male mice", *Toxicol. Lett.* 89:71-76, 1996.
12. Plaitakis, A. and Caroscio, J.T., "Abnormal glutamate metabolism in amyotrophic lateral sclerosis", *Ann. Neuro.* 22:575-579, 1987.
13. Blaylock, R.L., "Neurodegeneration and aging of the central nervous system: Prevention and treatment by phytochemicals and metabolic nutrients", *Integrative Med.* 1:117-133, 1998.
14. Olney, J.W., "Excitotoxic food additives: functional teratological aspects", *Prog. Brain Res.* 18:283-294, 1988.
15. Parsons, R.B., Waring, R.H. et al., "In vitro effect of the cysteine metabolites homocysteic acid, homocysteine and cysteic acid upon human neuronal cell lines", *Neurotoxicology* 19:599-603, 1998.
16. Esskes, T.K., "Neural tube defects, vitamins and homocysteine", *Eur. J. Pediatr.* 157(Suppl 2):S139-S141, 1998.
17. McCaddon, A., Daves, G. et al., "Total serum homocysteine in senile dementia of Alzheimer type", *J. Geriatr. Psychiatry* 13:235-239, 1998.
18. Banks, J.C. et al., "Retinal pathology in Alzheimer's disease. I. Ganglion cell loss in foveal/parafoveal retina", *Neurobiol. Aging* 17:377-384, 1996.
19. Onanow, C.W., "A radical hypothesis for neurodegeneration", *Trends in Neurosci.* 16:439-444, 1993.
20. Aisen, P.S. and Davis, K.L., "Inflammatory mechanisms in Alzheimer's disease: implications for therapy", *Am. J. Psych.* 151:1105-1113, 1994.
21. Murphey, T., Parikh, A. et al., "Arachidonic acid metabolism in glutamate neurotoxicity", *Ann. NY Acad. Sci.* 559:474-477, 1989.
22. Smith, M.A., Richey, P.I. et al., "Widespread peroxynitrite-mediated damage in Alzheimer's disease", *J. Neurosci.*

Continued on page 82

## Excitotoxins: Dangerous Food Additives

Continued from page 81

17:2653-2657, 1997.

23. Jenner, P. et al., "Oxidative stress as a cause of nigral cell death in Parkinson's disease and incidental Lewy body disease", *Ann. Neurol.* 32:282-287, 1992.

24. Griffiths, P.D. and Crossman, A.R., "Distribution of iron in the basal ganglion and neocortex in Parkinson's disease and Alzheimer's disease", *Dementia* 2:61-65, 1993.

25. Bolanos, J.P., Almeida, A. et al., "Nitric oxide-mediated mitochondrial damage in the brain: mechanisms and implications for neurodegenerative diseases", *J. Neurochem.* 68:2227-2240, 1997.

26. Dexter, D.T. et al., "Increased iron content in post-mortem Parkinsonian brain", *Lancet* ii:219-220, 1987.

27. Hirsch, E.C., Brandel, J.P. et al., "Iron and aluminum increase in the substantia nigra of patients with Parkinson's disease: an X-ray microanalysis", *J. Neurochem.* 56:446-451, 1991.

28. Logroscino, G., Marder, K., Graziano, J. et al., "Altered systemic iron metabolism in Parkinson's disease", *Neurology* 49:714-717, 1997.

29. Schapira, A.H.V. et al., "Mitochondrial complex I deficiency in Parkinson's disease", *J. Neurochem.* 54:823-827, 1990.

30. Bergerson, C., "Oxidative stress: Its role in the pathogenesis of amyotrophic lateral

sclerosis", *Neurol. Sci.* 129:81-84, 1995.

31. Gerlach, M., Ben-Shachar, D. et al., "Altered brain metabolism of iron as a cause of neurodegenerative diseases", *J. Neurochem.* 63:793-807, 1994.

32. Dawson, V.L., Dawson, T.M. et al., "Mechanisms of nitric oxide-mediated neurotoxicity in primary brain cultures", *J. Neurosci.* 13:2651-2661, 1993.

33. Williams, L.R., "Oxidative stress, age-related neurodegeneration, and the potential for neurotrophic treatment", *Cerebrovasc. Brain Metab. Rev.* 7:55-73, 1995.

34. Domenico, E., Pellegrini-Giampietro et al., "Excitatory amino acid release and free radical formation may cooperate in the genesis of ischemia-induced neuronal damage", *J. Neurosci.* 10:1035-1041, 1990.

35. Mundy, W.R., Freudenrich, T.M. and Kodavanti, P.R., "Aluminum potentiates glutamate-induced calcium accumulation and iron-induced oxygen free radical formation in primary neuronal cultures", *Mol. Chem. Neuropathol.* 32:41-57, 1997.

36. Aarala, J.T., Loikkanen, J.J. et al., "Lead amplifies glutamate-induced oxidative stress", *Free Radical Biol. Med.* 19:689-693, 1995.

37. Lipton, S.A. and Nicotera, P., "Calcium, free radicals and excitotoxins in neuronal apoptosis", *Cell Calcium* 23:165-171, 1998.

38. Murphey, T.H. et al., "Immature cortical neurons are uniquely sensitive to glutamate toxicity by inhibition of cystine uptake", *J. FASEB* 6:1624-1633, 1990.

39. Fahn, S., "A pilot trial of high-dose alpha-tocopherol and ascorbate in early Parkinson's disease", *Ann. Neurol.* 32:S128-S132, 1992.

40. Niki, E., "Interactions of ascorbate and alpha-tocopherol", *Third Conference of Vitamin C*, Burns, E.T. (ed.), *Ann. NY Acad. Sci.* 498:186-199, 1987.

41. Beal, M.F., Hyman, B.T. and Koroschetz, W., "Do defects in mitochondrial energy metabolism underlie the pathology of neurodegenerative diseases?", *Trends in Neurosci.* 16:125-131, 1993.

42. Pall, H.S., Blake, D.R. et al., "Raised cerebrospinal fluid copper concentration in Parkinson's disease", *Lancet* Aug 1:238-241, 1987.

43. Sorg, O., Horn, T.F. et al., "Inhibition of astrocyte glutamate uptake by reactive oxygen species: role of antioxidant enzymes", *Mol. Med.* 7:431-440, 1997.

### Editor's Note:

This article is reproduced courtesy of Dr Russell Blaylock and was first published in *Medical Sentinel* (vol. 4, no. 6, Nov-Dec 1999), the bimonthly peer-reviewed journal of the Association of American Physicians and Surgeons (AAPS) [Hacienda Publishing, Inc., PO Box 13648, Macon, GA 31208-3648, USA, tel (912) 757 9873, fax (912) 757 9725, e-mail hfaria@mindspring.com, website www.haciendapub.com].

Continued next issue ...

## Deadly Sounds: Dr Gavreau's Infrasonic Weapon

Continued from page 44

who saw its size would believe it to contain such lethal power. Most would overlook the device completely. A flood of such devices, each emanating a peculiar, highly modulated blend of infrasound, would be an unstoppable wall. Robotic tanks equipped with infrasonic generators could sweep an area with deadly infrasound, destroying all opponents to within a five-mile radius. These terrifying infrasonic weapons could easily be secured in drone jets, where aerial assaults could quickly and methodically waste any approaching army on the offensive.

Deterring would-be aerial attackers could be equally devastating for the offenders. Infrasonic beacons could sweep and scan the skies with lethal accuracy. Infrasound passes through all matter with equal effectiveness, seeking out offenders with deadly consequence.

The intensities which the Gavreau devices effectively broadcast into the environment are frightening. In these devices, we see the perfection of phenomena which never naturally occur in such dangerous intensities. This is why these weapons—if

used at all—must be deployed by remote control, operating as automatons at great distances from their operators.

In Gavreau's own words: "There does not exist complete protection against infrasound. It is not absorbed by ordinary matter; walls and chambers do not suffice to arrest it."

And so, once again, we stand at the crossroads. We are called, summoned to appear before two pathways. On the one, we hear Messiaen and the musical messages of peace; on the other, Gavreau and the musical messages of war. And again we choose. And again we *must* choose. Whose music will it be?

### References

- Fehr, "Infrasound from Artificial and Natural Sources", *Journal of Geophysical Research*, May 1967.
- Gavreau, V., "Infra-Sons", *Acustica*, vol. 17, 1966.
- Gavreau, V., "The Silent Sound That Kills", *Science and Mechanics*, January 1968.
- Gavreau's French patents: no. 131,551, "Infrasonic Generator"; no. 437,460, "Infrasonic Generator"; no.

1,536,289, "Infrasonic Shield".

- Mohr, "Effects of Low Frequency Noise on Man", *Aerospace Medicine*, September 1965.

### Editor's Note:

This article is published with permission from the Borderland Sciences Research Foundation (BSRF). It was first published (in part) in *The Journal of Borderland Research* (4th quarter, 1996), and was also published as chapter 8 of Gerry Vassilatos's book, *Lost Science* (1998, ISBN 0-945685-25-4, BSRF, Inc., PO Box 220, Bayside, CA 95524, USA, tel +1 (707) 825 7733, e-mail info@borderlands.com, website www.borderlands.com).

### About the Author:

Gerry Vassilatos is an underground science researcher and regular contributor to *The Journal of Borderland Research*. He produced the *Ray of Discovery* video documentary series and is the author of *Vril Compendium*, *Secrets of Cold War Technology: Project HAARP and Beyond*, *Declassified Patents of the Cold War and SDI* and *Lost Science* (see review in NEXUS 5/03).

### Continued from page 52

by an exposure of the water to a radionic rate (as opposed to dilution-succussion), then what?

24. Ideas about "form fields" have been expounded at length by Dr Rupert Sheldrake, who has proposed the concept of "morphogenetic" (roughly, "structure-creating") fields in his theory of formative causation. Morphogenetic fields exist in a dimension beyond time and space, as it is currently understood, but they are nevertheless inextricably entwined with "normal" reality. (See *The Presence of The Past*, Fontana, 1988, ISBN 0-00-637466-2). One of the reasons I was originally attracted to Sheldrake's work was that Sir John Maddox, former editor of the prestigious scientific journal *Nature*, apparently called *The Presence* a "book for burning" in his review of it. I definitely considered such a level of disapproval to be a recommendation. In July 1988, Sir John Maddox published Dr Jacques Benveniste's paper on homoeopathy, and soon afterwards went personally to Benveniste's laboratory in France to examine his experiments, with a technical support crew which included the famous magician and star of stage and screen, James Randi. As I understand it, the result of this was that Benveniste was rubbished by Maddox, ostracised by the French scientific community,

and lost his laboratory and his funding—even though other French scientists later repeated his experiments and validated his findings.

25. Quoted in *Dimensions of Radionics*, by Tansley, Rae and Westlake, 1977.

### Radionics Bibliography

There are a number of useful books on radionic techniques, but I suggest these as being especially useful:

- *Radionics and the Subtle Anatomy of Man*, by David Tansley, published by C.W. Daniel & Co., 1972, ISBN 0-85032-089-5.
- *Chakras, Rays and Radionics*, by David Tansley, published by C.W. Daniel & Co., 1984, ISBN 0-85207-161-2. This also contains a chapter by John Damonte on the miasms.
- *Dimensions of Radionics*, by David Tansley, Malcolm Rae and Aubrey Westlake, published by Brotherhood of Light, 1977, ISBN 0-914732-29-3.

### Radionics Equipment Suppliers

There are four suppliers of radionics equipment that I know of in the UK:

- Copen Instruments Ltd, tel 01444 487900, fax 01444 483555.
- Magneto-Geometric Applications (founded by Malcolm Rae), tel 0181 461 2220, fax 0181 461 5253.
- McGurk Electrical Services,

tel 0121 453 9898, fax 0121 457 9609.

- Tony Bassett, at No. 1 Electronics, tel 0171 431 2613, custom-makes equipment.

### Radionics Information

- The official body in the UK is The Radionic Association, tel/fax +44 (0)1869 338852.
- A comprehensive radionics resource guide is available at [www.methuselah.org/schwingung](http://www.methuselah.org/schwingung).

### About the Author:

Nick Franks was born in Manchester, England, in 1951 and graduated from Manchester University in 1973 with a degree in Economics. He co-founded a professional audio electronics company and was managing director and later chairman until he left the company in 1997.

Nick began studying Alice Bailey material in 1991, classical homoeopathy in 1994 and radionics in 1995 and is self-taught. He is currently practising radionics and has applied to the Radionic Association for membership.

Nick would be glad to hear from anyone with an interest in radionics, homoeopathy or related topics. He can be contacted by fax at +44 (0)1625 549809, by e-mail at [nick@nicko500.co.uk](mailto:nick@nicko500.co.uk), or by post at PO Box 93, Wilmslow, Cheshire SK9 5FF, UK. Visit his website, [www.nicko.com](http://www.nicko.com), for additional information including a more complete list of sources and resources.